

MODEL
PC35CWF

REFRIGERANT
R290

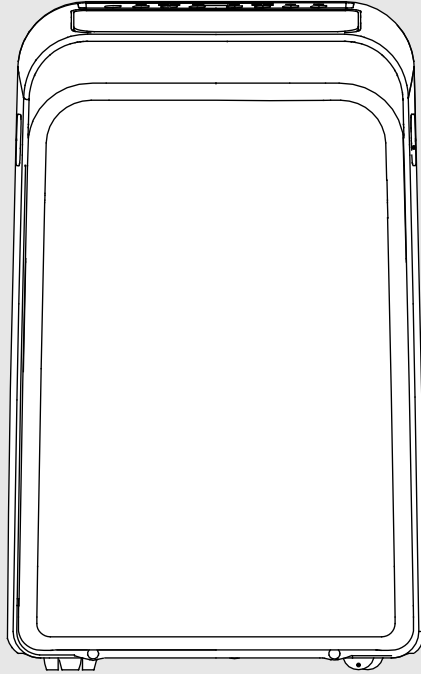

POLOCOOL Portable Room Air Conditioner

Operation & Installation Manual

POLO
by Rinnai

For continued safety of this appliance it must be installed and maintained in accordance with the manufacturer's instructions.

Before proceeding with the operation of your new Portable Room Air Conditioner, please read this manual thoroughly and gain a full understanding of the requirements, features and operation of your new appliance.



Table of Contents

Safety Precautions

Important Information	04
Safety Precautions	05

Introduction

Introduction	13
Warnings and Important Information	14

Specifications

Specifications	14
Mandatory Inspection Prior to Installation	14

Installation Instructions

Preparation	15
Design Notice	15
Ambient Temperature Range For Unit Operating	15
Exhaust Hose Installation	15
Choosing The Right Location	16
Recommended Installation	16
Tools Needed.....	17
Accessories	17
Window Installation Kit	18
Installation	19

Operating Instructions

Control Panel Features	21
Operation Instructions	22
Other Features	23

Remote Control Operation

Remote Control Specifications	25
Remote Control Functions.....	26
Handling the Remote Control	27
Remote Control LED Screen Indicators	28
Basic Functions	29
Timer Function.....	31
Advanced Functions	35
Wireless Operation	36

Maintenance

Safety Precautions	37
Air Filter Cleaning	37
Unit Cleaning	37
Store the unit when not in use	38

Troubleshooting Tips

Troubleshooting Tips	39
----------------------------	----

Warranty

Terms of Warranty	40
-------------------------	----

Important Information

Important Issues Regarding the Proper Use of this Air Conditioner

Please contact your supplier for advice before returning unit

Use this air conditioner only as described in this instruction manual.

- This appliance is fitted with a special safety device. When the compressor switches off or when the appliance is first turned on, this device prevents the compressor from switching on again for at least three minutes.
- This air conditioner has been designed and manufactured to operate in a domestic situation only and should not be used for other purposes.
- The appliance is not intended for use by persons (including children) with reduced physical, sensory or mental capabilities, or lack of experience and knowledge, unless they have been given supervision or instruction concerning use of the appliance by a person responsible for their safety. Children should be supervised to ensure they don't play with the appliance.
- Never use the air conditioner in damp rooms (eg bathrooms and laundries).
- If the power cord is damaged, it must be replaced with a new cord installed by a suitably qualified person.
- This air conditioner is designed to be connected to a standard 10 amp power supply outlet.
- Do not pull on or place strain on the power cord when using the appliance.
- Do not operate or stop the appliance by inserting or pulling out the power plug. Use the on/off switch on the air conditioner control panel or the remote control.
- Do not connect to multiple power outlets on extension leads.
- Do not rest hot or heavy objects on the appliance.
- Always unplug the unit from the power outlet before cleaning or maintenance operations, for example filter cleaning.
- Do not place the air conditioner or plastic window slider in direct sunlight.
- For maximum cooling efficiency keep the exhaust hose as short and as free of bends as possible.
- Clean the filters at least once every two weeks.
- Do not splash the unit with water.
- Do not move the unit by pulling the exhaust hose attached to the back of the unit.
- Do not move air conditioner when it is operating.
- Do not use the unit with the air intake and outlet grills closed, covered or obstructed.
- Before transporting, drain the water tray. After transportation, wait at least one hour before switching the unit on.
- The unit should be transported in a vertical position. If this is not possible, secure the unit at an angle, do not lay it horizontally. After transporting, wait at least one hour before switching the unit on.
- Do not operate the air conditioner outdoors or in areas open to the outdoors.
- If the air conditioner is correctly set and runs without cool air coming out of the front air outlet after 10 minutes of correct operation, switch off the unit and contact your supplier immediately.
- When cool air is coming out of the top air outlet, hot air should always be expelled from the bottom rear outlet. If it is not, switch off and contact your supplier immediately.

THIS PRODUCT IS FOR HOUSEHOLD USE ONLY

RETAIN THIS MANUAL FOR FUTURE REFERENCE

Safety Precautions

Read Safety Precautions before Operation and Installation.

To prevent death or injury to the user or other people and property damage, the following instructions **MUST** be followed. Incorrect operation due to ignoring instructions may cause death harm or damage.



WARNING

This symbol indicates the possibility of personal injury or loss of life.



CAUTION

This symbol indicates the possibility of property damage or serious consequences.



WARNING

- Installation must be performed according to the installation instructions. Improper installation can cause water leakage, electrical shock, or fire.
- Use only the included accessories and parts, and specified tools for the installation. Using non-standard parts can cause water leakage, electrical shock, fire, and injury or property damage.
- Make sure that the outlet you are using is grounded and has the appropriate voltage. The power cord is equipped with a three-prong grounding plug to protect against shock. Voltage information can be found on the nameplate of the unit.
- Ensure your unit is connected to a properly earthed electrical socket. Verify that the chosen socket is both adequately earthed and equipped with a fuse or circuit breaker for protection. Refer to the data plate on the unit to determine the maximum required current. If the current socket lacks proper earthing or the necessary protection, it is critical to have a qualified electrician install the correct earthed outlet.
- Install the unit on a flat, sturdy surface. Failure to do so could result in damage or excessive noise and vibration.
- The unit must be kept free from obstruction to ensure proper function and to mitigate safety hazards.
- Do not modify the length of the power cord or use an extension cord to power the unit.
- Do not share a single outlet with other electrical appliances. Improper power supply can cause fire or electrical shock.
- Do not install your air conditioner in a wet room such as a bathroom or laundry room. Too much exposure to water can cause electrical components to short circuit.
- Do not install the unit in a location that may be exposed to combustible gas, as this could cause fire.
The unit has wheels to facilitate moving. Make sure not to use the wheels on thick carpet or to roll over objects, as these could cause tipping.
- Do not operate a unit that it has been dropped or damaged.
- The appliance with electric heater shall have at least 1 meter space to the combustible materials.
- Do not touch the unit with wet or damp hands or when barefoot.
- If the air conditioner is knocked over during use, turn off the unit and unplug it from the main power supply immediately. Visually inspect the unit to ensure there is no damage. If you suspect the unit has been damaged, contact a technician or customer service for assistance.

- In a thunderstorm, the power must be cut off to avoid damage to the machine due to lightning.
- Your air conditioner should be used in such a way that it is protected from moisture. e.g. condensation, splashed water, etc. Do not place or store your air conditioner where it can fall or be pulled into water or any other liquid. Unplug immediately if it occurs.
- All wiring must be performed strictly in accordance with the wiring diagram located inside of the unit.
- The unit's circuit board (PCB) is designed with a fuse to provide overcurrent protection. The specifications of the fuse are printed on the circuit board, such as: T 3.15A/250V, etc.
- When the water drainage function is not in use, keep the upper and the lower drain plug firmly to the unit to get rid of choking. When the drain plug is not in use, keep it carefully to prevent children from choking.

**CAUTION**

- This appliance is not intended for use by persons (including children) with reduced physical, sensory or mental capabilities or lack of experience and knowledge, unless they have been given supervision or instruction concerning use of the appliance by a person responsible for their safety. Children should be supervised to ensure that they do not play with the appliance.
- Children must be supervised around the unit at all times.
- If the supply cord is damaged, it must be replaced by the manufacturer, its service agent or similarly qualified persons in order to avoid a hazard.
- Prior to cleaning or other maintenance, the appliance must be disconnected from the supply mains.
- Do not remove any fixed covers. Never use this appliance if it is not working properly, or if it has been dropped or damaged.
- Do not run cord under carpeting. Do not cover cord with throw rugs, runners, or similar coverings. Do not route cord under furniture or appliances. Arrange cord away from traffic area and where it will not be tripped over.
- Do not operate unit with a damaged cord, plug, power fuse or circuit breaker. Discard unit or return to an authorized service facility for examination and/or repair.
- To reduce the risk of fire or electric shock, do not use this fan with any solid-state speed control device.
- The appliance shall be installed in accordance with national wiring regulations.
- Contact the authorised service technician for repair or maintenance of this unit.
- Contact the authorised installer for installation of this unit.
- Do not cover or obstruct the inlet or outlet grilles.
- Do not use this product for functions other than those described in this instruction manual.
- Before cleaning, turn off the power and unplug the unit.

- Disconnect the power if strange sounds, smell, or smoke comes from it.
- Do not press the buttons on the control panel with anything other than your fingers.
- Do not remove any fixed covers. Never use this appliance if it is not working properly, or if it has been dropped or damaged.
- Do not operate or stop the unit by inserting or pulling out the power cord plug.
- Do not use hazardous chemicals to clean or come into contact with the unit. Do not use the unit in the presence of inflammable substances or vapour such as alcohol, insecticides, petrol, etc.
- Always transport your air conditioner in a vertical position and stand on a stable, level surface during use.
- Always contact a qualified person to carry out repairs. If the damaged power supply cord must be replaced with a new power supply cord obtained from the product manufacturer and not repaired.
- Hold the cord by the head of the power plug when taking it out.
- Turn off the product when not in use.

DISPOSAL GUIDELINES

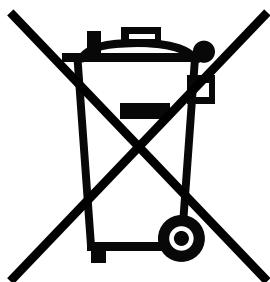

This appliance contains refrigerant and other potentially hazardous materials. When disposing of this appliance, the law requires special collection and treatment. **DO NOT** dispose of this product as household waste or unsorted municipal waste.



Special notice – Disposing of this appliance in the forest or other natural surroundings endangers your health and is bad for the environment. Hazardous substances may leak into the ground water and enter the food chain.



Using R290 Refrigerant

- Do not use means to accelerate the defrosting process or to clean, other than those recommended by the manufacturer.
- The appliance shall be stored in a room without continuously operating ignition sources (for example: open flames, an operating gas appliance or an operating electric heater).
- Do not pierce or burn.
- Be aware that the refrigerants may not contain an odour.
- Appliance should be installed, operated and stored in a room with a floor area according to the amount of refrigerant to be charged. For specific information on the type of gas and the amount, please refer to the relevant label on the unit itself. When there are differences between the label and the manual on the Min room area description, the description on the label shall prevail.

Minimum room area for R290			
Amount of refrigerant (kg)	Min. room area (m ²)	Amount of refrigerant (kg)	Min. room area (m ²)
≤0.0836	4	>0.1881 and ≤ 0.2090	10
>0.0836 and ≤ 0.1045	5	>0.2090 and ≤ 0.2299	11
>0.1045 and ≤ 0.1254	6	>0.2299 and ≤ 0.2508	12
>0.1254 and ≤ 0.1463	7	>0.2508 and ≤ 0.2717	13
>0.1463 and ≤ 0.1672	8	>0.2717 and ≤ 0.2926	14
>0.1672 and ≤ 0.1881	9	>0.2926 and ≤ 0.3040	15

- Compliance with local gas regulations and standards shall be observed.
- Keep ventilation openings clear of obstruction.
- The appliance shall be stored so as to prevent mechanical damage from occurring.
- A warning that the appliance shall be stored in a well-ventilated area where the room size corresponds to the room area as specified for operation.
- Any person who is involved with working on or breaking into a refrigerant circuit should hold a current valid certificate from an industry-accredited assessment authority, which authorises their competence to handle refrigerants safely in accordance with an industry recognised assessment specification.
- Servicing shall only be performed as recommended by the equipment manufacturer. Maintenance and repair requiring the assistance of other skilled personnel shall be carried out under the supervision of the person competent in the use of flammable refrigerants.
- Please follow the instructions carefully to handle, install, service or clear the air conditioner to avoid any damage or hazard. When maintaining or disposing the air conditioner, the refrigerant (R290) shall be disposed of properly. It MUST not be discharged directly into the air.
- No any open fire or device like switch which may generate spark/arcing shall be around air conditioner to avoid causing ignition of the flammable refrigerant used. Please follow the instruction carefully to store or maintain the air conditioner to prevent mechanical damage from occurring.
- The appliance MUST NOT be stored in a room with continuous operating open flames (for example an operating gas appliance) and ignition sources (for example an operating electric heater).

Explanation of symbols displayed on the unit (For units using R290 Refrigerant only):



Caution: Risk of fire/
flammable materials

	WARNING	This symbol shows that this appliance uses a flammable refrigerant. If the refrigerant is leaked and exposed to an external ignition source, there is a risk of fire.
	CAUTION	This symbol shows that the operation manual should be read carefully.
	CAUTION	This symbol shows that a service personnel should be handling this equipment with reference to the installation manual.
	CAUTION	This symbol shows that information is available such as the operating manual or installation manual.

1. Transport of equipment containing flammable refrigerants
See transport regulations
2. Marking of equipment using signs
See local regulations
3. Disposal of equipment using flammable refrigerants
See national regulations.
4. Storage of equipment/appliances
The storage of equipment should be in accordance with the manufacturer's instructions.
5. Storage of packed (unsold) equipment
Storage package protection should be constructed such that mechanical damage to the equipment inside the package will not cause a leak of the refrigerant charge. The maximum number of pieces of equipment permitted to be stored together will be determined by local regulations.
6. Information on servicing
 - 1) Checks to the area
Prior to beginning work on systems containing flammable refrigerants, safety checks are necessary to ensure that the risk of ignition is minimised. For repair to the refrigerating system, the following precautions shall be complied with prior to conducting work on the system.
 - 2) Work procedure
Work shall be undertaken under a controlled procedure so as to minimise the risk of a flammable gas or vapour being present while the work is being performed.
 - 3) General work area
All maintenance staff and others working in the local area shall be instructed on the nature of work being carried out. Work in confined spaces shall be avoided. The area around the workspace shall be sectioned off. Ensure that the conditions within the area have been made safe by control of flammable material.
 - 4) Checking for presence of refrigerant
The area shall be checked with an appropriate refrigerant detector prior to and during work, to ensure the technician is aware of potentially flammable atmospheres. Ensure that the leak detection equipment being used is suitable for use with flammable refrigerants, i.e. non-sparking, adequately sealed or intrinsically safe.
 - 5) Presence of fire extinguisher
If any hot work is to be conducted on the refrigeration equipment or any associated parts, appropriate fire extinguishing equipment shall be available to hand. Have a dry powder or CO₂ fire extinguisher adjacent to the charging area.
 - 6) No ignition sources
No person carrying out work in relation to a refrigeration system which involves exposing any pipe work that contains or has contained flammable refrigerant shall use any sources of ignition in such a manner that it may lead to the risk of fire or explosion. All possible ignition sources, including cigarette smoking, should be kept sufficiently far away from the site of installation, repairing, removing and disposal, during which flammable refrigerant can possibly be released to the surrounding space. Prior to work taking place, the area around the equipment is to be surveyed to make sure that there are no flammable hazards or ignition risks. No Smoking signs shall be displayed.
 - 7) Ventilated area
Ensure that the area is in the open or that it is adequately ventilated before breaking into the system or conducting any hot work. A degree of ventilation shall continue during the period that the work is carried out. The ventilation should safely disperse any released refrigerant and preferably expel it externally into the atmosphere.

8) Checks to the refrigeration equipment

Where electrical components are being changed, they shall be fit for the purpose and to the correct specification. At all times the manufacturer's maintenance and service guidelines shall be followed. If in doubt consult the manufacturer's technical department for assistance. The following checks shall be applied to installations using flammable refrigerants:

The charge size is in accordance with the room size within which the refrigerant containing parts are installed;

The ventilation machinery and outlets are operating adequately and are not obstructed;

If an indirect refrigerating circuit is being used, the secondary circuit shall be checked for the presence of refrigerant; Marking to the equipment continues to be visible and legible. Markings and signs that are illegible shall be corrected;

Refrigeration pipe or components are installed in a position where they are unlikely to be exposed to any substance which may corrode refrigerant containing components, unless the components are constructed of materials which are inherently resistant to being corroded or are suitably protected against being so corroded.

9) Checks to electrical devices

Repair and maintenance to electrical components shall include initial safety checks and component inspection procedures. If a fault exists that could compromise safety, then no electrical supply shall be connected to the circuit until it is satisfactorily dealt with. If the fault cannot be corrected immediately but it is necessary to continue operation, an adequate temporary solution shall be used. This shall be reported to the owner of the equipment so all parties are advised.

Initial safety checks shall include:

That capacitors are discharged: this shall be done in a safe manner to avoid possibility of sparking;

That there no live electrical components and wiring are exposed while charging, recovering or purging the system; That there is continuity of earth bonding.

7. Repairs to sealed components

1) During repairs to sealed components, all electrical supplies shall be disconnected from the equipment being worked upon prior to any removal of sealed covers, etc. If it is absolutely necessary to have an electrical supply to equipment during servicing, then a permanently operating form of leak detection shall be located at the most critical point to warn of a potentially hazardous situation.

2) Particular attention shall be paid to the following to ensure that by working on electrical components, the casing is not altered in such a way that the level of protection is affected. This shall include damage to cables, excessive number of connections, terminals not made to original specification, damage to seals, incorrect fitting of glands, etc. Ensure that apparatus is mounted securely. Ensure that seals or sealing materials have not degraded such that they no longer serve the purpose of preventing the ingress of flammable atmospheres. Replacement parts shall be in accordance with the manufacturer's specifications.

NOTE: The use of silicon sealant may inhibit the effectiveness of some types of leak detection equipment. Intrinsically safe components do not have to be isolated prior to working on them.

8. Repair to intrinsically safe components

Do not apply any permanent inductive or capacitance loads to the circuit without ensuring that this will not exceed the permissible voltage and current permitted for the equipment in use. Intrinsically safe components are the only types that can be worked on while live in the presence of a flammable atmosphere. The test apparatus shall be at the correct rating. Replace components only with parts specified by the manufacturer. Other parts may result in the ignition of refrigerant in the atmosphere from a leak.

9. Cabling

Check that cabling will not be subject to wear, corrosion, excessive pressure, vibration, sharp edges or any other adverse environmental effects. The check shall also take into account the effects of aging or continual vibration from sources such as compressors or fans.

10. Detection of flammable refrigerants

Under no circumstances shall potential sources of ignition be used in the searching for or detection of refrigerant leaks. A halide torch (or any other detector using a naked flame) shall not be used.

11. Leak detection methods

The following leak detection methods are deemed acceptable for systems containing flammable refrigerants. Electronic leak detectors shall be used to detect flammable refrigerants, but the sensitivity may not be adequate, or may need re-calibration. (Detection equipment shall be calibrated in a refrigerant-free area.) Ensure that the detector is not a potential source of ignition and is suitable for the refrigerant used. Leak detection equipment shall be set at a percentage of the LFL of the refrigerant and shall be calibrated to the refrigerant employed and the appropriate percentage of gas (25 % maximum) is confirmed. Leak detection fluids are suitable for use with most refrigerants but the use of detergents containing chlorine shall be avoided as the chlorine may react with the refrigerant and corrode the copper pipe-work. If a leak is suspected, all naked flames shall be removed/ extinguished. If a leakage of refrigerant is found which requires brazing, all of the refrigerant shall be recovered from the system, or isolated (by means of shut off valves) in a part of the system remote from the leak. Oxygen free nitrogen (OFN) shall then be purged through the system both before and during the brazing process.

12. Removal and evacuation

When breaking into the refrigerant circuit to make repairs or for any other purpose conventional procedures shall be used. However, it is important that best practice is followed since flammability is a consideration. The following procedure shall be adhered to:

Remove refrigerant; Purge the circuit with inert gas; Evacuate; Purge again with inert gas; Open the circuit by cutting or brazing.

The refrigerant charge shall be recovered into the correct recovery cylinders. The system shall be flushed with OFN to render the unit safe. This process may need to be repeated several times. Compressed air or oxygen shall not be used for this task. Flushing shall be achieved by breaking the vacuum in the system with OFN and continuing to fill until the working pressure is achieved, then venting to atmosphere, and finally pulling down to a vacuum. This process shall be repeated until no refrigerant is within the system. When the final OFN charge is used, the system shall be vented down to atmospheric pressure to enable work to take place. This operation is absolutely vital if brazing operations on the pipe-work are to take place. Ensure that the outlet for the vacuum pump is not close to any ignition sources and there is ventilation available.

13. Charging procedures

In addition to conventional charging procedures, the following requirements shall be followed. Ensure that contamination of different refrigerants does not occur when using charging equipment. Hoses or lines shall be as short as possible to minimise the amount of refrigerant contained in them.

Cylinders shall be kept upright.

Ensure that the refrigeration system is earthed prior to charging the system with refrigerant.

Label the system when charging is complete (if not already).

Extreme care shall be taken not to overfill the refrigeration system. Prior to recharging the system it shall be pressure tested with OFN. The system shall be leak tested on completion of charging but prior to commissioning. A follow up leak test shall be carried out prior to leaving the site.

14. Decommissioning

Before carrying out this procedure, it is essential that the technician is completely familiar with the equipment and all its detail. It is recommended good practice that all refrigerants are recovered safely. Prior to the task being carried out, an oil and refrigerant sample shall be taken in case analysis is required prior to re-use of reclaimed refrigerant. It is essential that electrical power is available before the task is commenced.

a) Become familiar with the equipment and its operation. b) Isolate system electrically. c) Before attempting the procedure ensure that: Mechanical handling equipment is available, if required, for handling refrigerant cylinders; All personal protective equipment is available and being used correctly; The recovery process is supervised at all times by a competent person; Recovery equipment and cylinders conform to the appropriate standards. d) Pump down refrigerant system, if possible. e) If a vacuum is not possible, make a manifold so that refrigerant can be removed from various parts of the system. f) Make sure that cylinder is situated on the scales before recovery takes place. g) Start the recovery machine and operate in accordance with manufacturer's instructions. h) Do not overfill cylinders. (No more than 80 % volume liquid charge). i) Do not exceed the maximum working pressure of the cylinder, even temporarily. j) When the cylinders have been filled correctly and the process completed, make sure that the cylinders and the equipment are removed from site promptly and all isolation valves on the equipment are closed off. k) Recovered refrigerant shall not be charged into another refrigeration system unless it has been cleaned and checked.

15. Labelling

Equipment shall be labelled stating that it has been de-commissioned and emptied of refrigerant. The label shall be dated and signed. Ensure that there are labels on the equipment stating the equipment contains flammable refrigerant.

16. Recovery

When removing refrigerant from a system, either for servicing or decommissioning, it is recommended good practice that all refrigerants are removed safely. When transferring refrigerant into cylinders, ensure that only appropriate refrigerant recovery cylinders are employed. Ensure that the correct number of cylinders for holding the total system charge is available. All cylinders to be used are designated for the recovered refrigerant and labelled for that refrigerant (i.e. special cylinders for the recovery of refrigerant). Cylinders shall be complete with pressure relief valve and associated shut-off valves in good working order. Empty recovery cylinders are evacuated and, if possible, cooled before recovery occurs. The recovery equipment shall be in good working order with a set of instructions concerning the equipment that is at hand and shall be suitable for the recovery of flammable refrigerants. In addition, a set of calibrated weighing scales shall be available and in good working order. Hoses shall be complete with leak-free disconnect couplings and in good condition. Before using the recovery machine, check that it is in satisfactory working order, has been properly maintained and that any associated electrical components are sealed to prevent ignition in the event of a refrigerant release. Consult manufacturer if in doubt. The recovered refrigerant shall be returned to the refrigerant supplier in the correct recovery cylinder, and the relevant Waste Transfer Note arranged. Do not mix refrigerants in recovery units and especially not in cylinders. If compressors or compressor oils are to be removed, ensure that they have been evacuated to an acceptable level to make certain that flammable refrigerant does not remain within the lubricant. The evacuation process shall be carried out prior to returning the compressor to the suppliers. Only electric heating to the compressor body shall be employed to accelerate this process. When oil is drained from a system, it shall be carried out safely.

Introduction

This portable air conditioner can alter the room temperature and humidity. It has multiple functions of cooling, dehumidifying (drying) and fan ventilation, and can be moved from room to room and transported from building to building easily. In addition, the desired humidity level can be set between 35-85%.

The air conditioner can maintain set room indoor air temperatures between 17°C and 30°C. The set room temperature is displayed on the remote control and in the control panel on the unit. This does not mean that the air conditioner will necessarily reduce the actual room temperature to the set room temperature. This appliance operates at half the noise levels of most other portable air conditioners and is ideal for bedrooms.

This POLOCOOL portable refrigerated air conditioner model PC35CWF has a maximum cooling capacity of 3.50 kW.

This is sufficient to cool rooms with a floor area of between 12 and 18 square metres.

- Do not place the air conditioner or plastic window slider in direct sunlight. Close all curtains in the room being cooled.
- For maximum cooling (COOLING MODE), set the temperature at 18°C and the fan at HIGH. After approximately 3 minutes, the compressor will turn on and cooled air will come out of the front air outlet. Warm air will also come out of the rear outlet and into the exhaust hose.
- In COOLING MODE the air conditioner will not cool unless the set temperature is below the existing room temperature.
- In COOLING MODE once the existing room temperature reaches the set temperature, the fan continues operating and the compressor switches on and off to maintain the set temperature within the room.
- For maximum cooling output keep the exhaust hose as short and as straight as possible. Minimise bends which can reduce the maximum cooling capacity of the air conditioner. Elevate the air conditioner if necessary.
- Make sure the air intake and outlet grills are unobstructed.
- Clean the filters at least once every two weeks.

Warnings and Important Information

Warning information regarding appliances with R290 refrigerant gas.

Thoroughly read all of the warnings.

- This appliance contains 210g of R290 refrigerant gas.
- The appliance must be installed, used and stored in a ventilated area that is greater than 9m².
- When cleaning the appliance, do not use any tools other than those recommended by the manufacturing company.
- The appliance must be placed in an area without any continuous sources of ignition (for example: open flames, gas or electrical appliances in operation).
- Do not puncture and do not burn.
- Refrigerant gases can be odourless.
- If the appliance is installed, operated or stored in a non-ventilated area, the room must be designed to prevent the accumulation of refrigerant leaks resulting in a risk of fire or explosion due to ignition of the refrigerant caused by electric heaters, stoves, or other sources of ignition.
- The appliance must be stored in such a way as to prevent mechanical failure.
- Repairs must be performed based on the recommendations from the manufacturing company. Maintenance and repairs that require the assistance of other qualified personnel must be performed under the supervision of an individual specified in the use of flammable refrigerants.



Specifications

MODEL		PC35CWF
Power Supply	V/Hz	220-240V / 50
Dimensions - Net (H x W x D)	mm	765 x 467 x 397
Weight	kg	32.5
Nominal Cooling Capacity	kW	3.5
Rated Input Current	A	5.9
Rated Input Power	kW	1.23
Max. Input Current	A	8.0
Max. Input Power	kW	1.45
Refrigerant	Type	R290
Refrigerant Volume	g	210
Sound Power Level	dB(A)	63.5

Mandatory Inspection Prior to Installation

Immediately report any damage or discrepancies to the Supplier of the appliance. This appliance was inspected and tested at the time of manufacture and packaging, and released for transportation without known damage. Upon receipt, inspect the exterior for evidence of rough handling in shipment. Ensure that the appliance is labelled correctly for the gas and electrical supply, and/or other services it is intended to be connected to.

For safety and warranty purposes, appliances that may be damaged or incorrect **MUST NOT** be installed or operated under any circumstances. Installation of damaged or incorrect appliances may contravene local government regulations. Rinnai disclaims any liability or responsibility whatsoever in relation to the installation or operation of damaged or incorrect appliances.

Installation Instructions

Preparation

NOTE:

All the illustrations in the manual are for explanation purpose only. Your machine may be slightly different. The actual shape shall prevail. The unit can be controlled by the unit control panel alone or with the remote controller. This manual does not include Remote Controller Operations, see the <<Remote Controller Instruction>> packed with the unit for details.

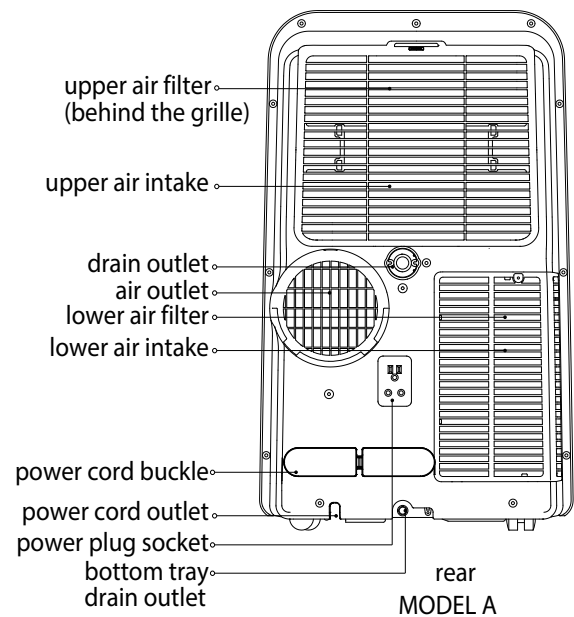
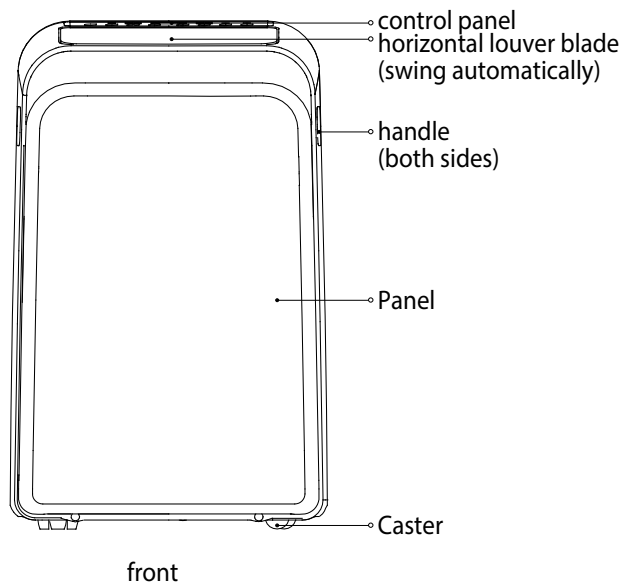

Design Notice

In order to ensure the optimal performance of our products, the design specifications of the unit and remote control are subject to change without prior notice.

Ambient Temperature Range For Unit Operating

MODE	Temperature Range
Cool	17-35°C
Dry	13-35°C

Exhaust Hose Installation

The exhaust hose and adaptor must be installed or removed in accordance with the usage mode. For COOL or AUTO mode, an exhaust fan must be installed. For FAN or DRY mode, the exhaust fan must be removed.

Choosing The Right Location

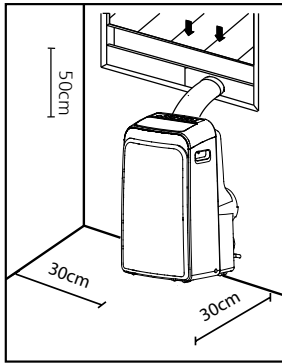

Your installation location should meet the following requirements:

- Make sure that you install your unit on an even surface to minimise noise and vibration.
- The unit must be installed near a grounded plug, and the Collection Tray Drain (found on the back of the unit) must be accessible.
- The unit should be located at least 30cm from the nearest wall to ensure proper air conditioning. The horizontal louver blade should be at least 50cm away from obstacles.
- DO NOT cover the Intakes, Outlets or Remote Signal Receptor of the unit, as this could cause damage to the unit.

Recommended Installation

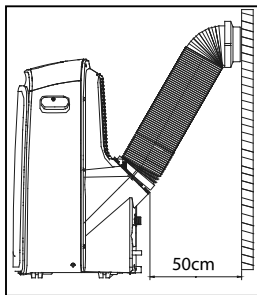

Energy Rating Information

The energy rating and noise information for this unit is based on the standard installation using an un-extended exhaust duct (Diameter:150mm, Length:1.5m) without window slider adaptor or wall exhaust adaptor A.

The unit with 3 meters extended exhaust duct is running by using 2 exhaust ducts (Diameter:150mm, Length:1.5m + Diameter: 130mm, Length: 1.5m). The Energy rating and noise information for unit with 3 meters extended exhaust duct is not assessed. (For some models)

NOTE :











We recommend that operating the unit at room temperature below 35°C . Since there is a risk that the unit with 3 metres extended exhaust duct would not work at room temperature above 35°C under some extreme conditions, such as the lower air intake be blocked for 50%.

Tools Needed

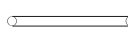
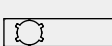
- Medium Philips screwdriver; -Tape measure or ruler; -Knife or scissors;
- Saw (On some models, to shorten window adaptor for narrow windows)

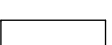
Accessories

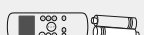
NOTE: Items with (*) are on some models. Slight variations in design may occur.

Shape	Name of Accessories	Qty.	Shape	Name of Accessories	Qty.
	Unit Adaptor	1 pc		Exhaust Hose Adaptor	1 pc(*)
	Exhaust Hose	1 pc		Security Bracket and 2 Screws	1 set(*)
	Window Slider Adaptor	1 pc(*)		Drain Hose	1 pc
	Window Slider A	1 pc(*)		Power Cord Buckle	1 pc
	Window Slider B	1 pc(*)		Bolt	1 pc(*)
	Foam Seal A (Adhesive)	2 pc(*)		Remote Controller and Battery (only for remote control models)	1 set(*)
	Foam Seal B (Adhesive)	2 pc(*)			
	Foam Seal C (Non-adhesive)	1 pc(*)			

Window Installation Kit

Window installation:

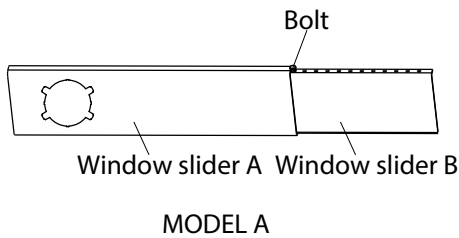
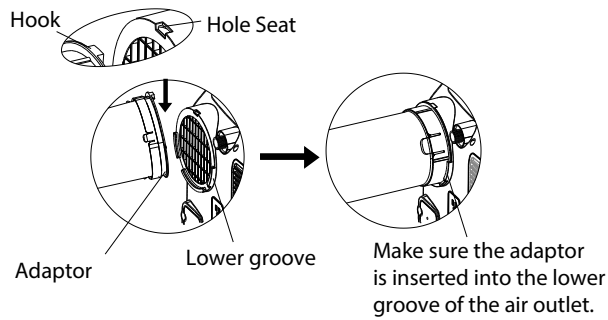
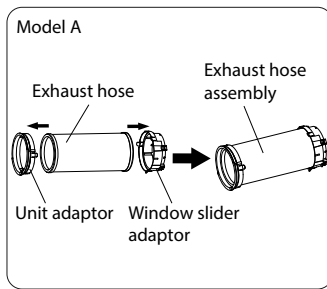

Step One: Preparing the Exhaust Hose assembly

Press the exhaust hose (or extended exhaust hose) into the window slider adaptor (or wall exhaust adaptor) and unit adaptor, clamp automatically by elastic buckles of the adaptors.

Step Two: Install the Exhaust hose assembly to the unit

Insert unit adaptor of the Exhaust hose assembly into the lower groove of the air outlet of the unit while the hook of the adaptor is aligned with the hole seat of the air outlet and slide down the Exhaust hose assembly along the arrow direction for installation.

Step Three: Preparing the Adjustable Window Slider

1. Choose the window sliders according the size of your window. Sometimes, it needs to be cut shorter to meet the window size, please take extra care to cut it properly.
2. Use bolts to fasten the window sliders once they are adjusted to the correct length.

Installation

NOTE: Once the Exhaust Hose assembly and Adjustable Window Slider are prepared, choose from one of the following two installation methods.

Type 1: Hung Window or Sliding Window Installation(For some models)

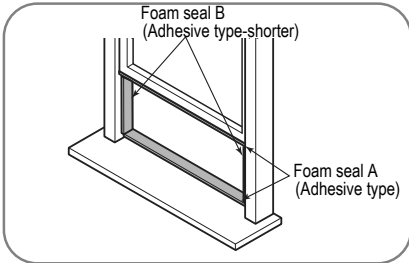

Or

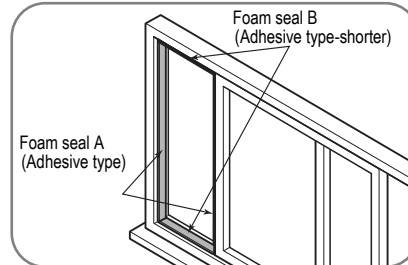

1. Cut the adhesive foam seal A and B strips to the proper lengths, and attach them to the window sash and frame as shown.

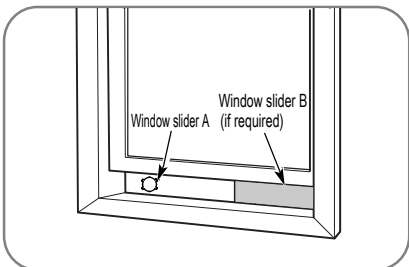

Or

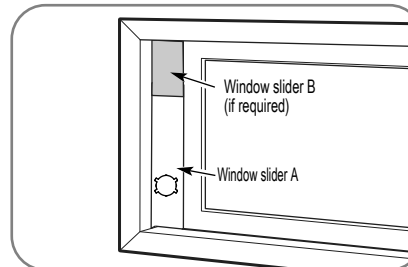

2. Insert the window slider assembly into the window opening.

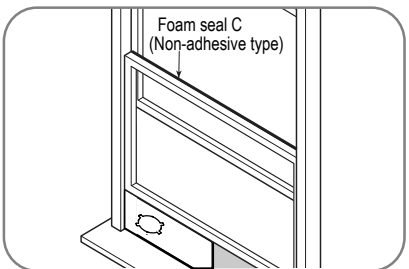

Or

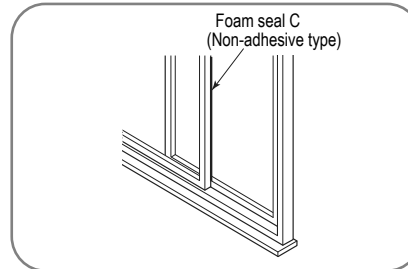

3. Cut the non-adhesive foam seal C strip to match the width(or height) of the window. Insert the seal between the glass and the window frame to prevent air and insects from getting into the room.

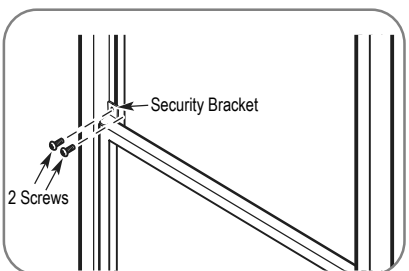

Or

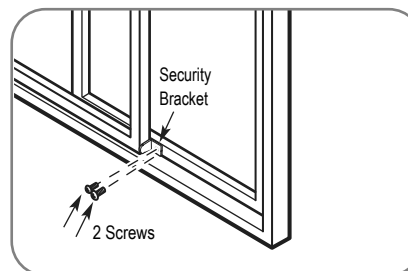

4. If desired, install the security bracket with 2 screws as shown.

MODEL A

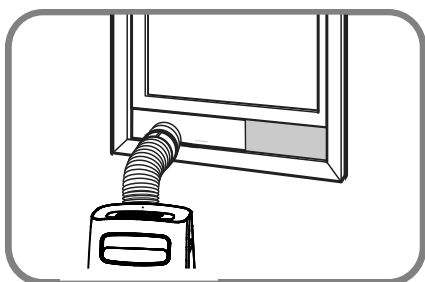

Or

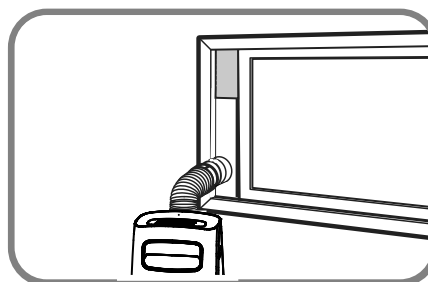

5. Insert the window slider adaptor into the hole of the window slider.

NOTE: To ensure proper function, DO NOT over extend or bend the hose. Make sure that there is no obstacle around the air outlet of the exhaust hose (in the range of 500mm) in order to the exhaust system works properly. All the illustrations in this manual are for explanation purposes only. Your air conditioner may be slightly different. The actual shape shall prevail.

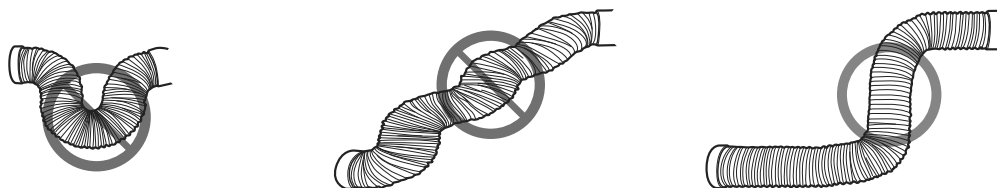







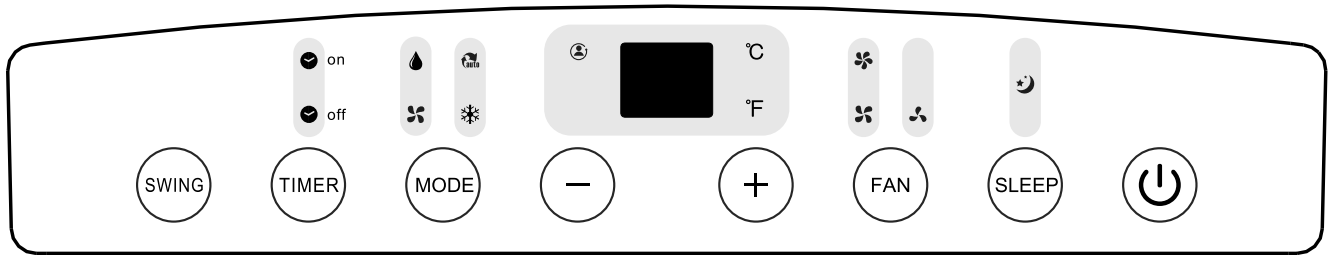





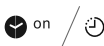







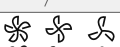

Operating Instructions

Control Panel Features

NOTE: The following control panels are for explanation purpose only. The control panel of the unit you purchased may be slightly different according to the models. Your machine may not contain some indicators or buttons. The actual shape shall prevail.



NOTE: On some models  is instead of °F. On some models  (power light) is instead of  (WIRELESS light).

Indicator	Function	Indicator	Function	Indicator	Function
	Timer on light;		Constant Fan light		Wireless light
	Timer off light;		HIGH fan speed light		Degrees Celsius
	DRY mode light		MED fan speed light		Degrees Fahrenheit
	FAN mode light		LOW fan speed light		LED display
	AUTO mode light		AUTO fan speed light (all illuminate/all dark)		Power management light
	COOL mode light		ION light		Power light
	FOLLOW ME light		SLEEP light		Fresh light

SWING Swing/Wireless (On some models) button
 (3 seconds) Used to initiate the Auto swing feature. When the operation is ON, press the SWING button can stop the louver at the desired angle. Used to initiate the Wireless function. For the first time to use Wireless function, press and hold the swing button for 3 seconds to initiate

connection. If connection (router) is successful within 8 minutes, the unit will exit Wireless connection mode automatically and the Wireless indicator illuminates. If connection is failure within 8 minutes, the unit exits Wireless connection mode automatically. After Wireless connection is successful, you can press and

and the LED DISPLAY shows 'OF' for 3 seconds, press SWING and UP (+) buttons at the same time to turn on Wireless function and the LED DISPLAY shows 'On' for 3 seconds.

NOTE: When you restart the Wireless function, it may take a period of time to connect to the network automatically.

TIMER Timer button
Used to initiate the AUTO ON start time and AUTO OFF stop time program, in conjunction with the + & - buttons. The timer on/off indicator light illuminates under the timer on/off settings.

MODE Mode button
Selects the appropriate operating mode. Each time you press the button, a mode is selected in a sequence that goes from AUTO, COOL, DRY, FAN. The mode indicator light illuminates under the different mode settings.

+ - Up (+) and Down (-) buttons
Used to adjust (increasing/decreasing) temperature settings in 1°C increments in a range of 17°C to 30°C or the TIMER setting in a range of 0~24hrs.
NOTE: The control is capable of displaying temperature in degrees Fahrenheit or degrees Celsius. To convert from one to the other, press and hold the Up and Down buttons at the same time for 3 seconds.

FAN
CONSTANT FAN(Press 3s) Fan/Constant fan (On some models) button
Control the fan speed. Press to select the fan speed in four steps-LOW, MED, HIGH and AUTO. The fan speed indicator light illuminates under different fan settings. When select AUTO fan speed, all the fan indicator lights turn dark. On some models, when select AUTO fan speed, all the fan indicator lights illuminate.

ION FRESH ION/Fresh feature (on some models)
Press FAN button for 3 seconds to initiate ION/FRESH feature and the ION/FRESH light illuminates (if applicable), the LED DISPLAY shows 'ON' for 3 seconds for some units. The ion generator is energised and will help to purify the air inside. Press it for 3 seconds again to stop the ION/FRESH feature and the ION/FRESH light turn dark (if applicable), the LED DISPLAY shows 'OF' for 3 seconds for some units.

SLEEP Sleep (Eco) button
Used to initiate the SLEEP/ECO operation.

 Power button
Power switch on/off.

 LED display
Shows the set temperature in °C or °F ("°F" no display for some models) and the Auto-timer settings. While on DRY and FAN modes, it shows the room temperature.
Shows Error codes and protection code:
E1-Room temperature sensor error.
E2-Evaporator temperature sensor error.
E3-Condenser temperature sensor error (On some models).
E4-Display panel communication error.
EC-Refrigerant leakage detection malfunction (On some models).
P1-Bottom tray is full--Connect the drain hose and drain the collected water away.If protection repeats, call for service.
Note: When one of the above malfunctions occurs, turn off the unit, and check for any obstructions. Restart the unit, if the malfunction is still present, turn off the unit and unplug the power cord. Contact the manufacturer or its service agents or a similar qualified person for service.

Operation Instructions

COOL operation

- Press the "MODE" button until the "COOL" indicator light comes on.
- Press the ADJUST buttons "+" or "-" to select your desired room temperature. The temperature can be set within a range of 17°C~30°C.
- Press the "FAN SPEED" button to choose the fan speed.

DRY operation

- Press the "MODE" button until the "DRY" indicator light comes on.
- Under this mode, you cannot select a fan speed or adjust the temperature. The fan motor operates at LOW speed.
- Keep windows and doors closed for the best dehumidifying effect.
- Do not put the duct to window.

AUTO operation

- When you set the air conditioner in AUTO mode, it will automatically select cooling, or fan only operation depending on what temperature you have selected and the room temperature.
- The air conditioner will control room temperature automatically round the temperature point set by you.
- Under AUTO mode, you can not select the fan speed.

NOTE: Under AUTO mode, both the AUTO mode and the actual operation mode indicator lights illuminate for some models.

FAN operation

- Press the "MODE" button until the "FAN" indicator light comes on.
- Press the "FAN SPEED" button to choose the fan speed. The temperature can not be adjusted.
- Do not put the duct to window.

TIMER operation

- When the unit is on, press the Timer button will

initiate the Auto-off stop program, the TIMER OFF indicator light illuminates. Press the UP or down button to select the desired time. Press the TIMER button again within 5 seconds, the Auto-on start program is initiated. And the TIMER ON indicator light illuminates. Press the up or down button to select the desired Auto-on start time.

- When the unit is off, press the Timer button to initiate the Auto-on start program, press it again within 5 seconds will initiate the Auto-off stop program.
- Press or hold the UP or DOWN button to change the Auto time by 0.5 hour increments, up to 10 hours, then at 1 hour increments up to 24 hours. The control will count down the time remaining until start.
- The system will automatically revert back to display the previous temperature setting if there is no operation in a 5 seconds period.
- Turning the unit ON or OFF at any time or adjusting the timer setting to 0.0 will cancel the Auto Start/Stop timer program.

SLEEP (ECO) operation

- Press this button, the selected temperature will increase (cooling) by 1°C every 30 minutes. The temperature will then increase (cooling) by another 1°C after an additional 30 minutes. This new temperature will be maintained for 7 hours before it returns to the originally selected temperature. This ends the Sleep/Eco mode and the unit will continue to operate as originally programmed.

NOTE: This feature is unavailable under FAN or DRY mode.

Other features

FOLLOW ME/TEMP SENSING feature(On some models)

NOTE: This feature can be activated from the remote control ONLY. The remote control serves as a remote thermostat allowing for the precise temperature control at its location.

To activate the Follow Me/Temp Sensing feature, point the remote control towards the unit and press the Follow Me/Temp Sensing button. The remote control will send this signal to the air conditioner until press the Follow Me/Temp Sensing button again. If the unit

does not receive the Follow Me/Temp Sensing signal during any 7 minutes interval, the unit will exit the Follow Me/Temp Sensing mode.

NOTE: This feature is unavailable under FAN or DRY mode.

AUTO-RESTART

If the unit breaks off unexpectedly due to the power cut, it will restart with the previous function setting automatically when the power resumes.

AIR FLOW DIRECTION ADJUSTMENT

The louver can be adjusted automatically. Adjust the air flow direction automatically:

- When the Power is ON, the louver opens fully.
- Press the SWING button on the panel or remote controller to initiate the Auto swing feature. The louver will swing up and down automatically.
- Please do not adjust the louver manually.

WAIT 3 MINUTES BEFORE RESUMING OPERATION

After the unit has stopped, it can not be restarted operation in the first 3 minutes. This is to protect the unit. Operation will automatically start after 3 minutes.

POWER MANAGEMENT feature(On some models)

Under cooling operation, when the ambient temperature is lower than the setting temperature for a period of time, the unit will be automatically operate power management feature. The compressor and fan motor stop. When the ambient temperature is higher than the setting temperature, the unit will be automatically quit the power management feature. The compressor and (or) fan motor run.

Water drainage

- During dehumidifying modes, remove the upper drain plug from the back of the unit, install the drain connector (5/8" universal female mender) with 3/4" hose (locally purchased). For the models without drain connector, just attach the drain hose to the hole. Place the open end of the hose directly over the drain area in your basement floor.

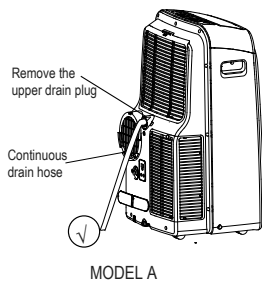

NOTE: Make sure the hose is secure so there are no leaks. Direct the hose toward the drain, making sure that there are no kinks that will stop the water flowing. Place the end of the hose into the drain and make sure the end of the hose is down to let the water flow smoothly.(See Figs with ☑). Do never let it up. (See Figs with ☒). When the continuous drain hose is not used, ensure that the corresponding drain plug and knob are installed firmly to prevent leakage.

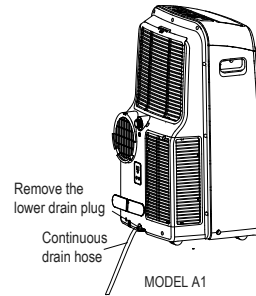

- When the water level of the bottom tray reaches a predetermined level, the unit beeps 8 times, the digital display area shows "P1".



At this time the air conditioning/dehumidification process will immediately stop. However, the fan motor will continue to operate (this is normal). Carefully move the unit to a drain location, remove the bottom drain plug and let the water drain away. Reinstall the bottom drain plug and restart the machine until the "P1" symbol disappears. If the error repeats, call for service.

NOTE: Be sure to reinstall the bottom drain plug firmly to prevent leakage before using the unit.

Remote Control Operation

Remote Control Specifications

Model	RG57H4(B)/BGEF
Rated Voltage	3.0V (Dry batteries R03/LR03×2)
Signal Receiving Range	8m
Range	-5°C~60°C

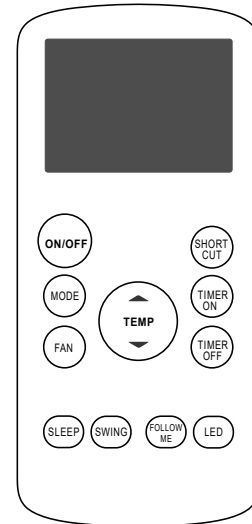

NOTE

- Buttons design is based on typical model and might be slightly different from the actual one you purchased, the actual shape shall prevail.
- All the functions described are accomplished by the unit, if the unit has no this feature, there is no corresponding operation happened when press the relative button on the remote controller.
- When there are wide differences between Remote controller Illustration and USERS MANUAL on function description, the description on USERS MANUAL shall prevail.
- The device could comply with the local national regulations. Operation is subject to the following two conditions: (1) This device may not cause harmful interference, and (2) this device must accept any interference received, including interference that may cause undesired operation.
- This equipment has been tested and found to comply with the limits for a Class B digital device, pursuant to part 15 of the FCC Rules. These limits are designed to provide reasonable protection against harmful interference in a residential installation. This equipment generates, uses and can radiate radio frequency energy and, if not installed and used in accordance with the instructions, may cause harmful interference to radio communications. However, there is no guarantee that interference will not occur in a particular installation. If this equipment does cause harmful interference to radio or television reception, which can be determined by turning the equipment off and on, the user is encouraged to try to correct the interference by one or more of the following measures:
 - Reorient or relocate the receiving antenna.
 - Increase the separation between the equipment and receiver.
 - Connect the equipment into an outlet on a circuit different from that to which the receiver is connected.
 - Consult the dealer or an experienced radio/TV technician for help. Changes or modifications not approved by the party responsible for compliance could void users authority to operate the equipment.

Remote Control Functions

Before you begin using your new air conditioner, make sure to familiarise yourself with its remote control. The following is a brief introduction to the remote control itself. For instructions on how to operate your air conditioner, refer to the **How to Use Basic Functions** section of this manual.

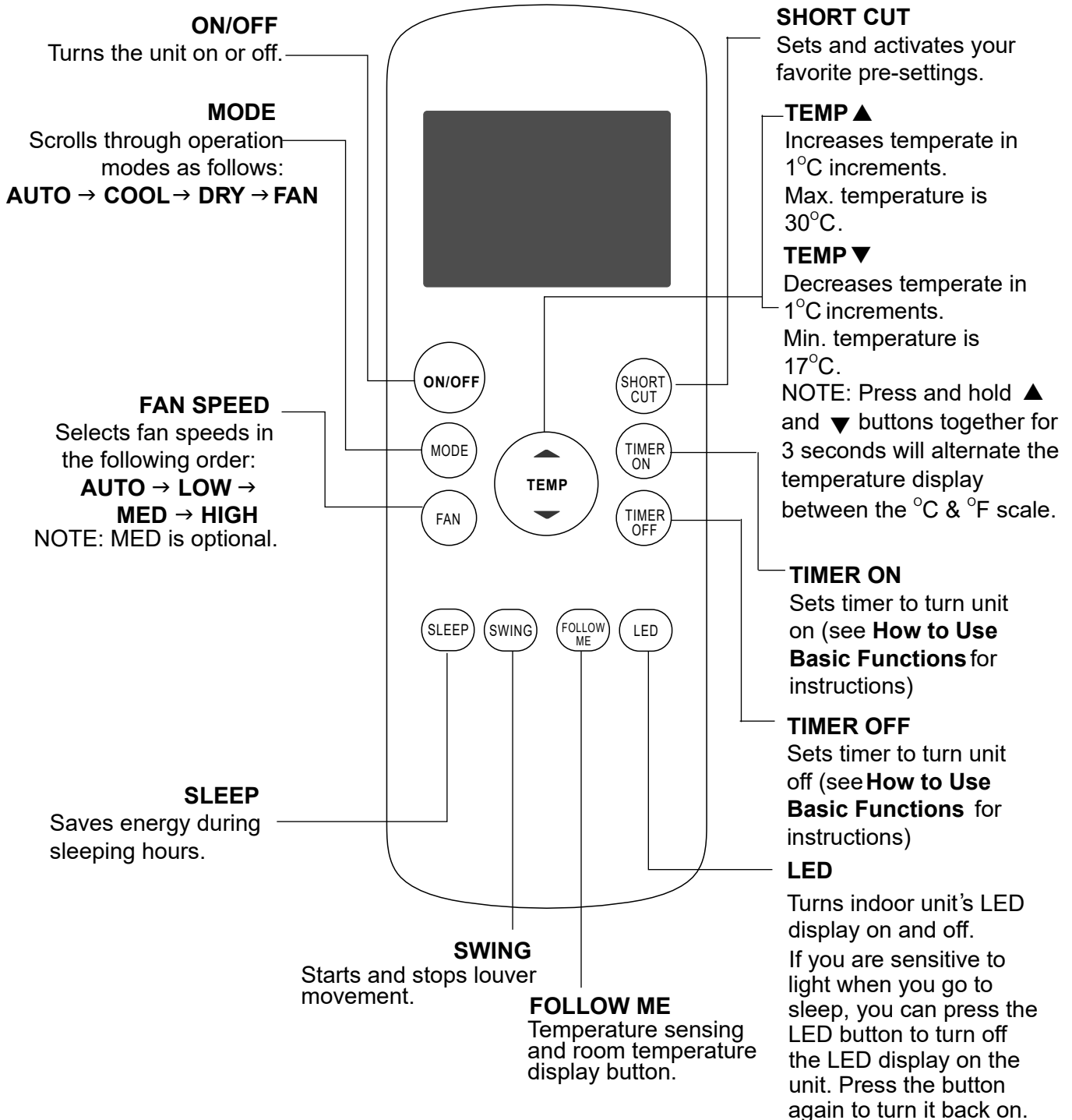

Handling the Remote Control

NOT SURE WHAT A FUNCTION DOES?

Refer to the How to Use Basic Functions and **How to Use Advanced Functions** sections of this manual for a detailed description of how to use your air conditioner.

SPECIAL NOTE

- Button designs on your unit may differ slightly from the example shown.
- If the unit does not have a particular function, pressing that function's button on the remote control will have no effect.
- When there are wide differences between "Remote control Illustration" and "USER'S MANUAL" on function description, the description of "USER'S MANUAL" shall prevail.

Inserting and Replacing Batteries

Your air conditioning unit comes with two AAA batteries. Put the batteries in the remote control before use.

1. Slide the back cover from the remote Control downward, exposing the battery compartment.
2. Insert the batteries, paying attention to match up the (+) and (-) ends of the batteries with the symbols inside the battery compartment.
3. Slide the battery cover back into place.

! BATTERY NOTES

For optimum product performance:

- Do not mix old and new batteries, or batteries of different types.
- Do not leave batteries in the remote control if you don't plan on using the device for more than 2 months.



BATTERY DISPOSAL

Do not dispose of batteries as unsorted municipal waste. Refer to local laws for proper disposal of batteries.

TIPS FOR USING REMOTE CONTROL

- The remote control must be used within 8 meters of the unit.
- The unit will beep when remote signal is received.
- Curtains, other materials and direct sunlight can interfere with the infrared signal receiver.
- Remove batteries if the remote will not be used more than 2 months.

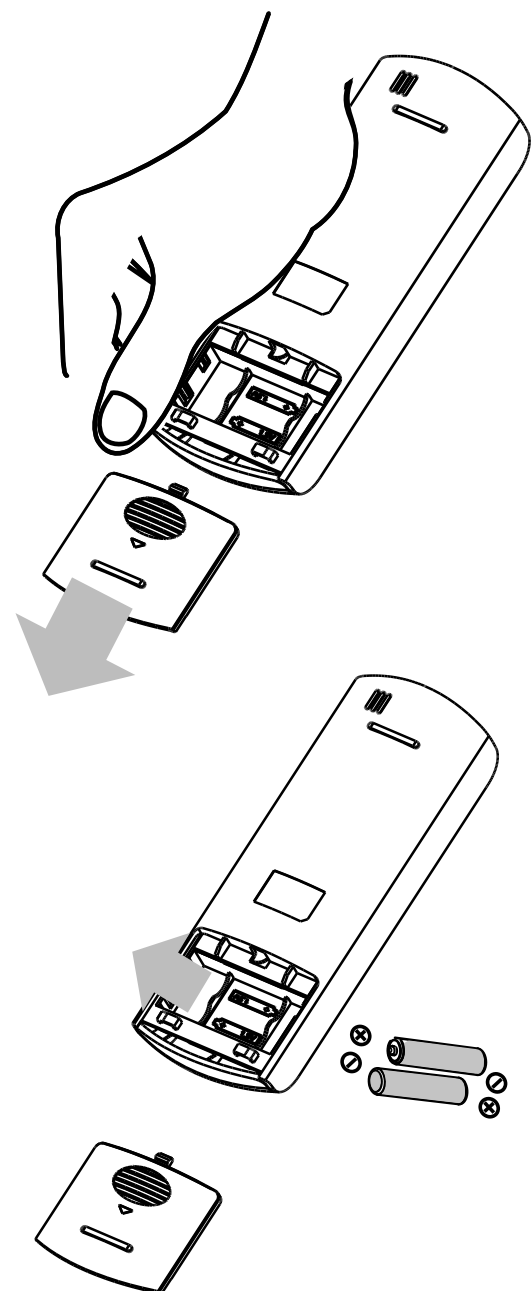

Remote LED Screen Indicators

Remote Control

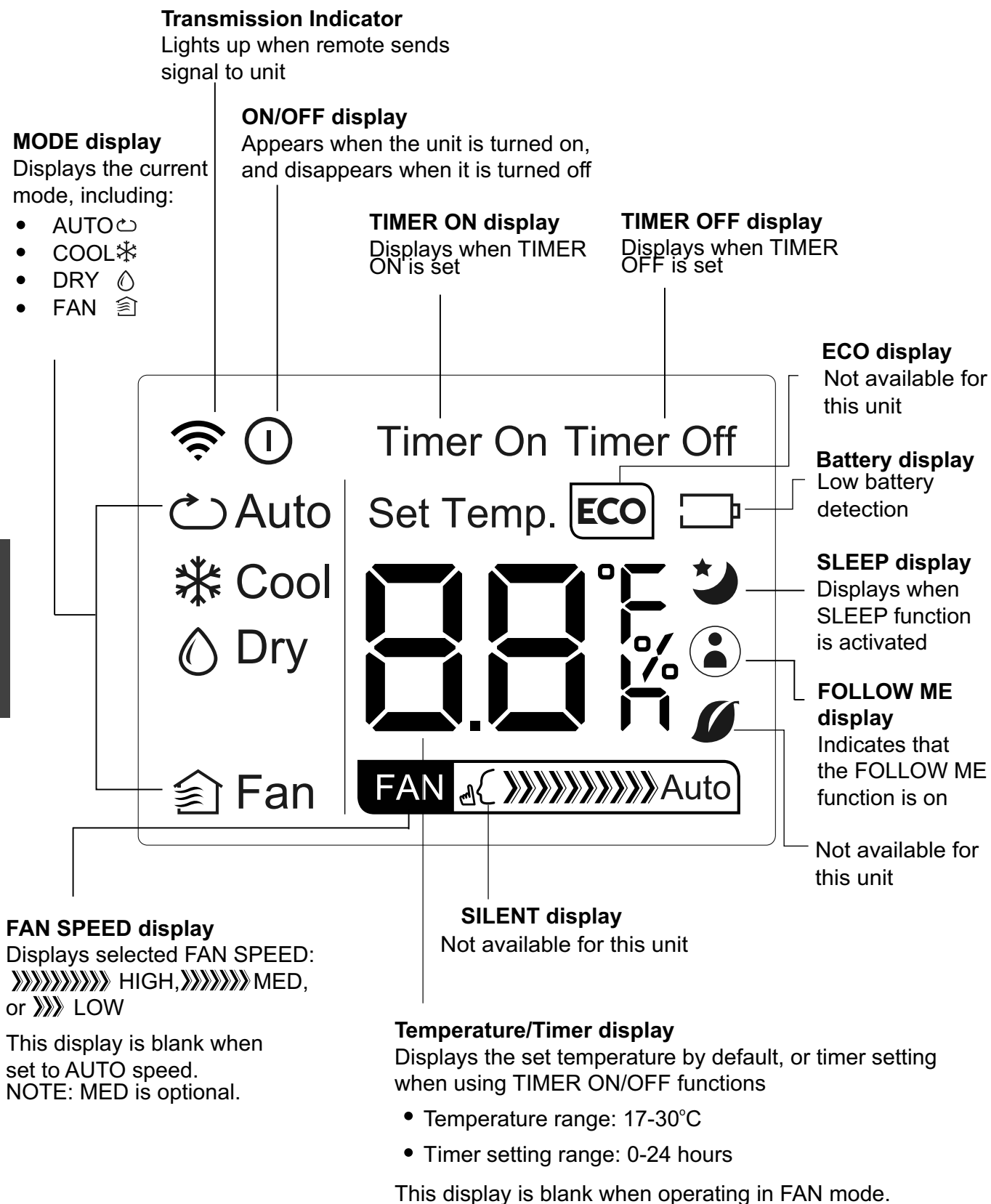

Basic Functions

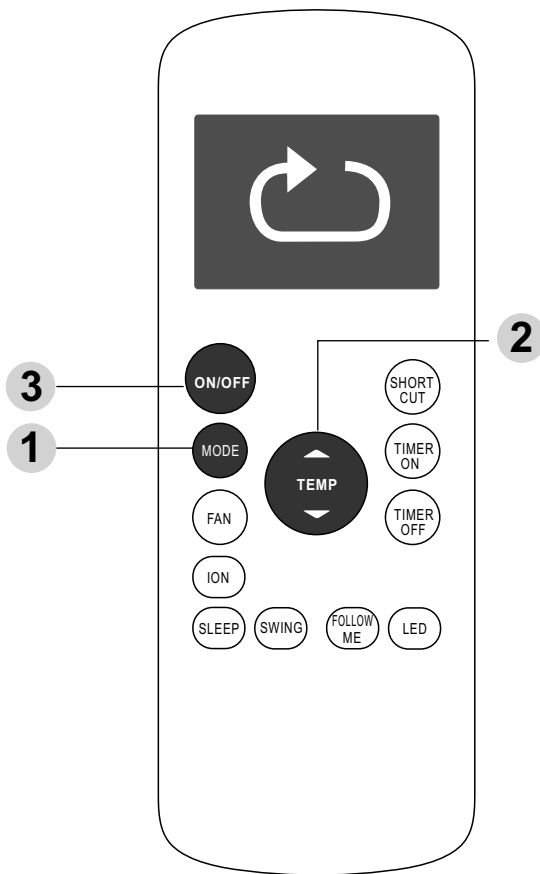

SETTING TEMPERATURE

The operating temperature range for units is 17-30°C. You can increase or decrease the set temperature in 1°C increments.

AUTO operation

In **AUTO** mode, the unit will automatically select the COOL, FAN or DRY mode based on the set temperature.

1. Press the **MODE** button to select Auto mode.
2. Set your desired temperature using the **Temp ▲** or **Temp ▼** button.
3. Press the **ON/OFF** button to start the unit.

NOTE: FAN SPEED can't be set in Auto mode.

COOL operation

1. Press the **MODE** button to select **COOL** mode.
2. Set your desired temperature using the **Temp ▲** or **Temp ▼** button.
3. Press the **FAN** button to select the fan speed: AUTO, LOW, MED, or HIGH.
4. Press the **ON/OFF** button to start the unit.

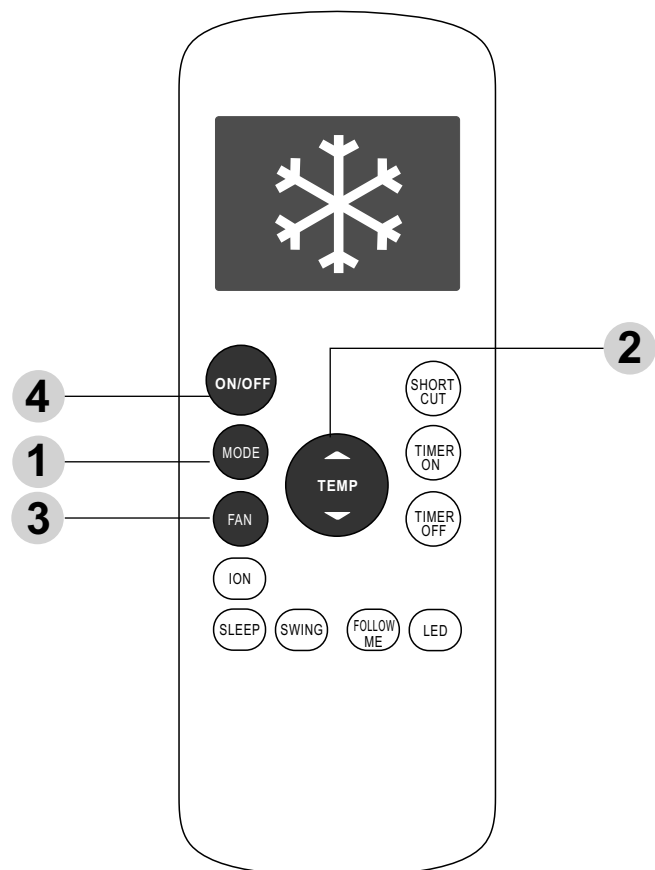

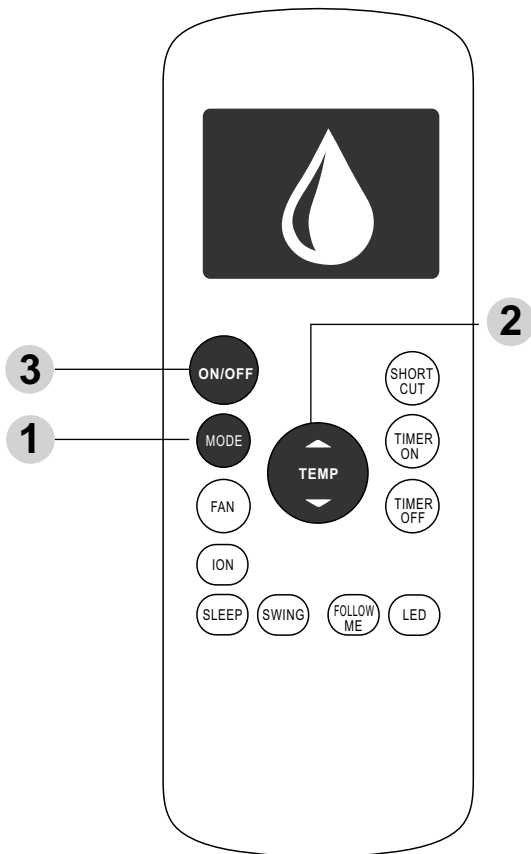

DRY operation (dehumidifying)

1. Press the **MODE** button to select **DRY** mode.
2. Set your desired temperature using the **Temp▲** or **Temp▼** button.
3. Press the **ON/OFF** button to start the unit.

NOTE: **FAN SPEED** can't be changed in **DRY** mode.

FAN operation

1. Press the **MODE** button to select **FAN** mode.
2. Press **FAN** button to select the fan speed: **AUTO**, **LOW**, **MED** or **HIGH**.
3. Press the **ON/OFF** button to start the unit.

NOTE: You can't set temperature in **FAN** mode. As a result, your remote control's LCD screen will not display temperature.

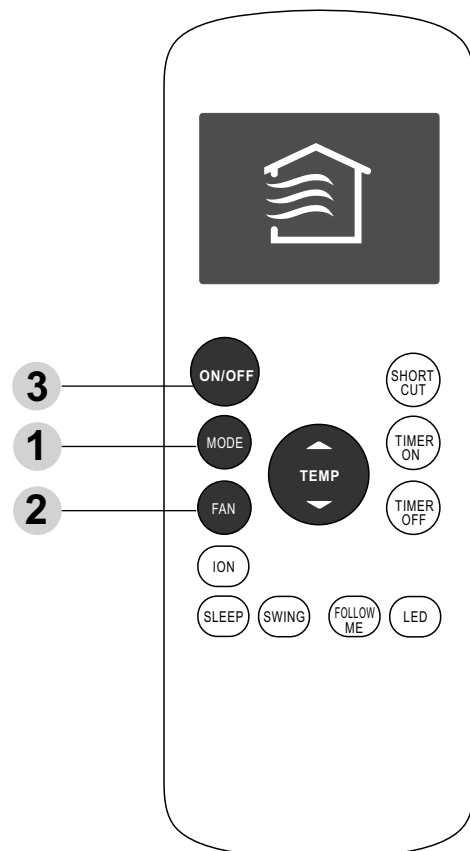

Timer Function

Your air conditioning unit has two timer-related functions:

TIMER ON- sets the amount of timer after which the unit will automatically turn on.

TIMER OFF- sets the amount of time after which the unit will automatically turn off.

TIMER ON function

The **TIMER ON** function allows you to set a period of time after which the unit will automatically turn on, such as when you come home from work.

1. Press the **TIMER ON** button. By default, the last time period that you set and an "h" (indicating hours) will appear on the display.
Note: This number indicates the amount of time after the current time that you want the unit to turn on. For example, if you set **TIMER ON** for 2 hours, " 2.0h " will appear on the screen, and the unit will turn on after 2 hours.
2. Press the **TIMER ON** button repeatedly to set the time when you want the unit to turn on.
3. Wait 2 seconds, then the **TIMER ON** function will be activated. The digital display on your remote control will then return to the temperature display.

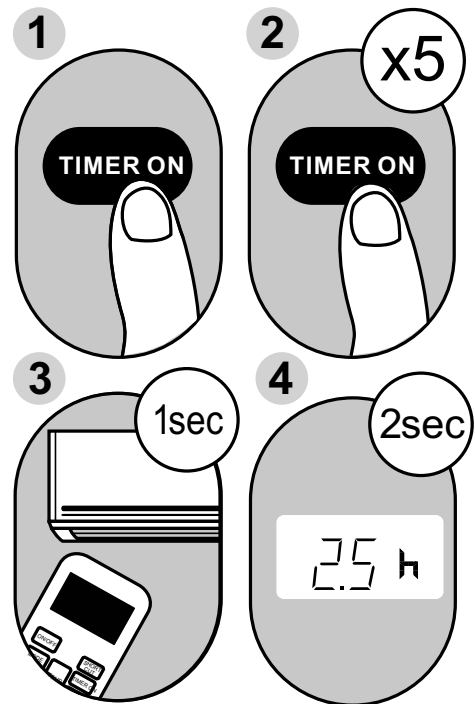

Example: Setting unit to turn on after 2.5 hours.

TIMER OFF function

The **TIMER OFF** function allows you to set a period of time after which the unit will automatically turn off, such as when you wake up.

1. Press the **TIMER OFF** button. By default, the last time period that you set and an "h" (indicating hours) will appear on the display.
Note: This number indicates the amount of time after the current time that you want the unit to turn off. For example, if you set **TIMER OFF** for 2 hours, " 2.0h " will appear on the screen, and the unit will turn off after 2 hours.
2. Press the **TIMER OFF** button repeatedly to set the time when you want the unit to turn off.
3. Wait 2 seconds, then the **TIMER OFF** function will be activated. The digital display on your remote control will then return to the temperature display.

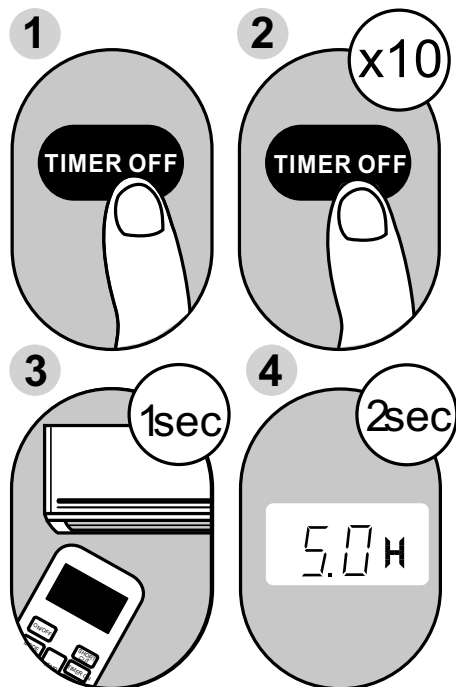

Example: Setting unit to turn off after 5 hours.

NOTE: When setting the **TIMER ON** or **TIMER OFF** functions, up to 10 hours, the time will increase in 30 minute increments with each press. After 10 hours and up to 24, it will increase in 1 hour increments. The timer will revert to zero after 24 hours. You can turn off either function by setting its timer to " 0.0h " .

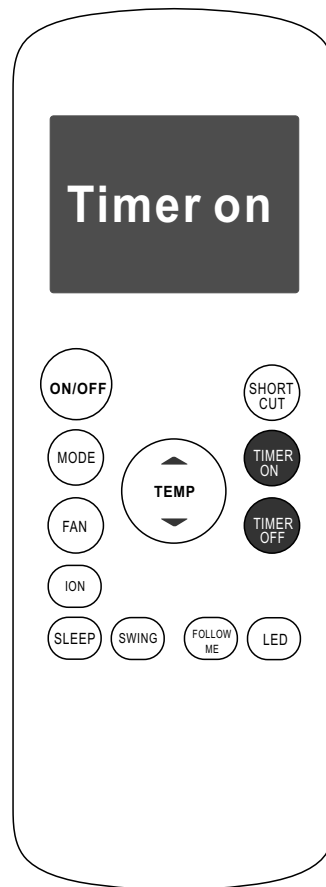

Continue to press **TIMER ON** or **TIMER OFF** until desired time is reached.

Setting both TIMER ON and TIMER OFF at the same time

Keep in mind that the time periods you set for both functions refer to hours after the current time. For example, say that the current time is 1:00 PM, and you want the unit to turn on automatically at 7:00 PM. You want it to operate for 2 hours, then automatically turn off at 9:00 PM.

Do the following:

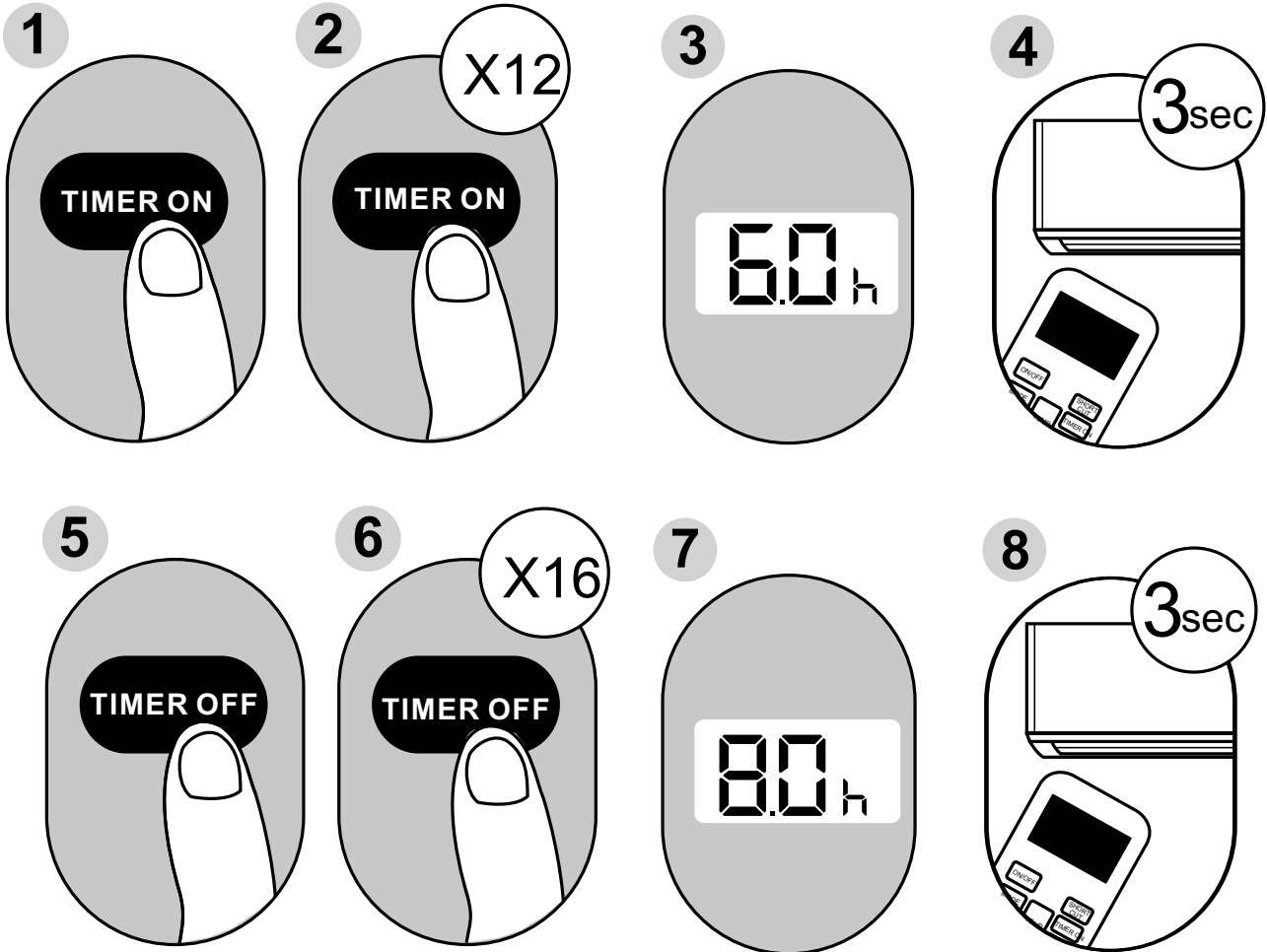

Example: Setting the unit to turn on after 6 hours, operate for 2 hours, then turn off (see the figure below)

Your remote display

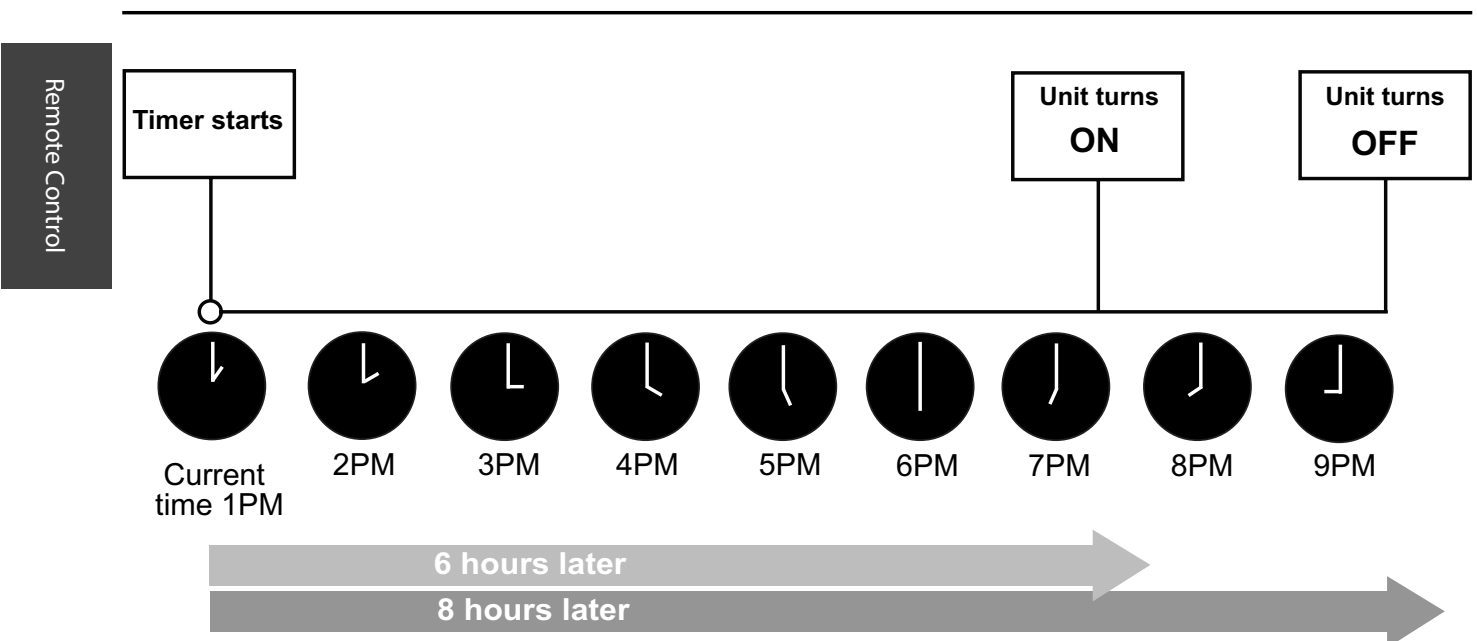
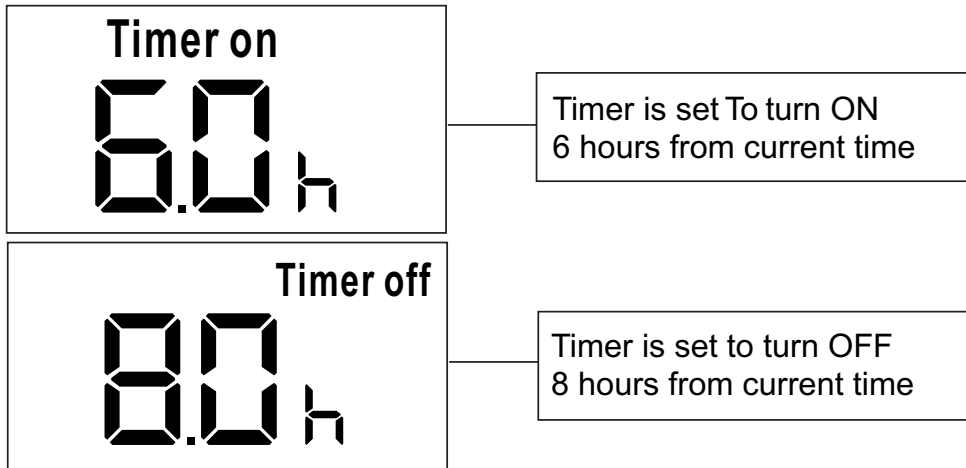

Advanced Functions

SLEEP Function

The SLEEP function is used to decrease energy use while you sleep (and don't need the same temperature settings to stay comfortable).

Note: The SLEEP function is not available in FAN or DRY mode.

SWING Function

Used to stop or start louver movement and set the desired up/down air flow direction. The louver changes 6 degrees in angle for each press (some models without). If keep pushing more than 2 seconds, the louver auto swing feature is activated.

FOLLOW ME function

The FOLLOW ME function enables the remote control to measure the temperature at its current location. When using AUTO or COOL functions, measuring ambient temperature from the remote control (instead of from the indoor unit itself) will enable the air conditioner to optimise the temperature around you and ensure maximum comfort.

1. Press **FOLLOW ME** button to activate function. The remote control will send temperature signal to the unit every three minutes.
2. Press **FOLLOW ME** button again to turn off this function.

SHORTCUT function

- Used to restore the current settings or resume previous settings.
- Push this button when remote controller is on, the system will automatically revert back to the previous settings including operating mode, setting temperature, fan speed level and sleep feature (if activated).
- If pushing more than 2 seconds, the system will automatically restore the current operation settings including operating mode, setting temperature, fan speed level and sleep feature (if activated).

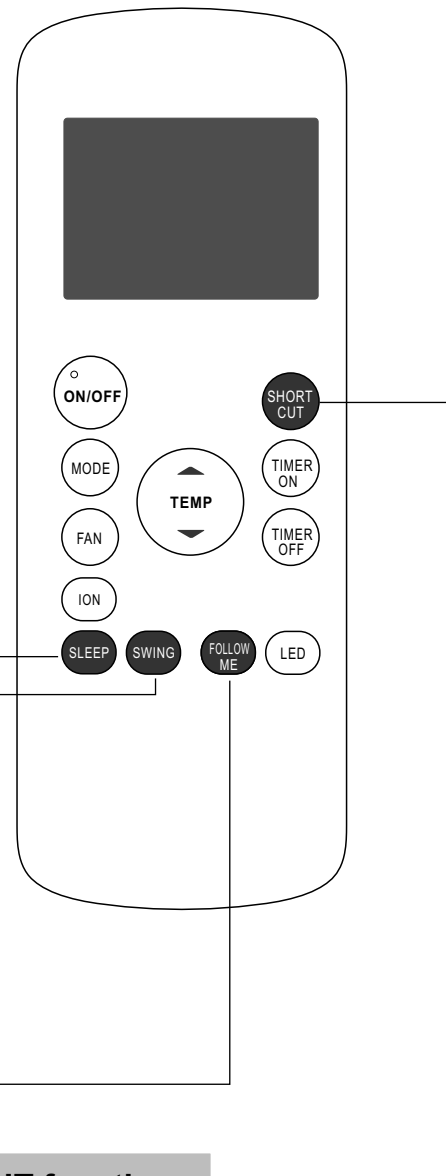

Wireless Operation

Visit your device app store (iOS or Android) to download the NetHome Plus APP. Once installed follow the procedure below to pair the device with your appliance.

- Please ensure your mobile device is connected to Wireless router. Also, the Wireless router has already connected to Internet before doing user registration and network configuration.
- Make sure your mobile device has already been connected to the Wireless network which you want to use. Also, you need to forget other irrelevant Wireless network in case it influences your configuration process.

Once connected you can fully control your appliance.

For further details, refer to the Wireless Operation Manual. A copy of the manual may be downloaded from the POLO COOL website: <http://www.mypolo.com.au/downloads/>

Maintenance

Safety Precautions

- Always unplug the unit before cleaning or servicing.
- DO NOT use flammable liquids or chemicals to clean the unit.
- DO NOT wash the unit under running water. Doing so causes electrical danger.
- DO NOT operate the machine if the power supply was damaged during cleaning. A damaged power cord must be replaced with a new cord from the manufacturer.

Air Filter Cleaning

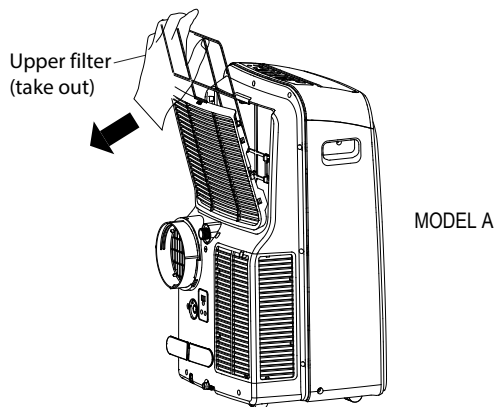

Removal

- Take the filter out along the arrow direction.

Cleaning

- Wash the air filter by immersing it gently in warm water (about 40°C) with a neutral detergent. Rinse the filter and dry it in a shady place.

Mounting

- Install the air filter after cleaning .

Maintenance Tips

- Be sure to clean the air filter every 2 weeks for optimal performance.
- The water collection tray should be drained immediately after P1 error occurs, and before storage to prevent mold.
- In households with animals, you will have to periodically wipe down the grill to prevent blocked airflow due to animal hair.



CAUTION
DO NOT operate the unit without filter because dirt and lint will clog it and reduce performance.

Unit Cleaning

Clean the unit using a damp, lint-free cloth and mild detergent. Dry the unit with a dry, lint-free cloth.

Store the unit when not in use

- Drain the unit's water collection tray according to the instructions in the following section.
- Run the appliance on FAN mode for 12 hours in a warm room to dry it and prevent mold.
- Turn off the appliance and unplug it.
- Clean the air filter according to the instructions in the previous section. Reinstall the clean, dry filter before storing.
- Remove the batteries from the remote control.

Note: Be sure to store the unit in a cool, dark place. Exposure to direct sunshine or extreme heat can shorten the lifespan of the unit.

Note: The cabinet and front may be dusted with an oil-free cloth or washed with a cloth dampened in a solution of warm water and mildliquid dishwashing detergent. Rinse thoroughly and wipe dry. Never use harsh cleansers, wax or polish on the cabinet front. Be sure to wring excess water from the cloth before wiping around the controls. Excess water in or around the controls may cause damage to the unit.



DO NOT REMOVE OR INSTALL THE LOWER FILTER BY YOURSELF. It **MUST** be performed by an authorised dealer or a licensed service Provider.

Troubleshooting Tips

Problem	Possible Causes	Solution
Unit does not turn on when pressing ON/OFF button	P1 Protection Code	The Water Collection Tray is full. Turn off the unit, drain the water from the Water Collection Tray and restart the unit.
	In COOL mode: room temperature is lower than the set temperature	Reset the temperature
Unit does not cool well	The air filter is blocked with dust or animal hair	Turn off the unit and clean the filter according to instructions
	Exhaust hose is not connected or is blocked	Turn off the unit, disconnect the hose, check for blockage and reconnect the hose
	The unit is low on refrigerant	Call a service technician to inspect the unit and top off refrigerant
	Temperature setting is too high	Decrease the set temperature
	The windows and doors in the room are open	Make sure all windows and doors are closed
	The room area is too large	Double-check the cooling area
The unit is noisy and vibrates too much	There are heat sources inside the room	Remove the heat sources if possible
	The ground is not level	Place the unit on a flat, level surface
The unit makes a gurgling sound	The air filter is blocked with dust or animal hair	Turn off the unit and clean the filter according to instructions
	This sound is caused by the flow of refrigerant inside the unit	This is normal

Terms of Warranty - Australia

Rinnai Australia Pty. Ltd. ABN 74 005 138 769, 100 Atlantic Drive, Keysborough VIC 3173.

1 DEFINITIONS

The terms listed below shall have the following meanings:

- 1 **“Authorised Service Representative”** means an independent service contractor authorised by Rinnai or Rinnai service personnel.
- 2 **“Rinnai”** means Rinnai Australia Pty Ltd (ABN 74 005 138 769) and any related company.
- 3 **“Certificate(s) of Compliance”** means certificate(s) issued by licensed personnel (including plumbers, refrigeration mechanics, electricians or other relevant tradespeople) to certify that any prescribed works comply with applicable regulatory requirements.
- 4 **“Certificate(s) of Occupancy”** means certificate(s) issued by the local government authority (or similar organisation) which certifies that a home can be occupied.
- 5 **“Installation Site”** means the site at which the Product is originally installed.
- 6 **“Normal Business Hours”** means 8:30am to 5:00pm Monday to Friday, excluding public holidays.
- 7 **“Operating/Installation Instructions”** means the user manual or other documentation which provides detailed instructions on the proper operation and maintenance of the Product.
- 8 **“Other Applications”** means any Product used for purposes other than Residential & Light Commercial Applications. Other Applications may include but are not limited to factory, IT/Server room, telephone exchange, processing area (e.g. bakery, kitchen, warehouse, swimming pool, agricultural facilities such as a nursery). Any Product which has been installed, for whatever purpose, as a retrofit component to an existing system, will also be classed as being part of an “Other Application” regardless of the purpose of use of the existing system into which such product has been installed.
- 9 **“Purchaser”** means the end user of the Product, the person named as owner in the Warranty certificate, the holder of the Proof of Purchase or the holder of a property transfer document where the Product is included as part of the chattels.
- 10 **“Product”** means the equipment purchased by the Purchaser and described in Section 2 of this document.
- 11 **“Proof of Purchase”** means a Tax Invoice or Receipt in respect of the Product. In the case of new constructions, a Certificate of Occupancy or a Certificate of Compliance that details the date of installation or commissioning will suffice.
- 12 **“Qualified Installer”** means the qualified installation contractor who is responsible for performing the installation work in the manner prescribed by local and statutory regulations, including compliance with any relevant and to Rinnai specifications, including Australian Standards.
- 13 **“Residential & Light Commercial Applications”** means any Product for use in residential or light commercial applications where
 - a) the Product is solely used for the purpose of human comfort; and
 - b) the ambient temperature of the space the Product is intended to heat or cool is influenced solely or primarily by natural exterior weather conditions rather than by man-made or mechanical heat sources.

Examples of Residential & Light Commercial Applications include, homes, offices, hotels, apartments, nursing homes, hospitals, health care premises, shopping centres, and retail stores.

2 TERMS OF WARRANTY

- 2.1 Subject to the Terms of Warranty set out in this document, effective from the date of purchase by the Purchaser, the Product is warranted to be free from defects in materials & factory workmanship for the period set out in table below:

	PRODUCT GROUPS	PARTS	LABOUR
Residential and Light Commercial	Evaporative Coolers & Ducted Gas Heaters (excluding Compact Classic Series)	5 Years *Extended 4 Years Option	5 Years *Extended 4 Years Option
	Ducted Gas Heaters - Compact Classic Series	3 Years	3 Years
	Refrigerated Air conditioning Products	5 Years	5 Years
	Ducted Gas Heaters - Heat Exchangers and Burners Evaporative Coolers - Structural components only	10 Years	N/A
	Portable Air conditioning / Dehumidifier / Air Purifier	2 Years	N/A
	Electric Panel Heaters ⁽¹⁾	7 Years	N/A
	Electric Fire Heater	5 Years	5 Years
	Wireless Devices	1 Year	1 Year
	Other Applications	All Product Groups	2 Years
After Market	Spare Parts	1 Year	N/A
*Extended Warranty Option	Up to 4 year extended warranty (in addition to the standard warranty period listed above) applies on selected products when you opt in to the Rinnai Service Advantage program. This program has terms and conditions, including the requirement for scheduled servicing of the product by Rinnai. To participate in the program you must register your product online at: www.rinnai.com.au/support-resources/warranty-registration/ within the first 12 months of the product being installed.		

⁽¹⁾ To make a claim under this warranty, please contact your place of purchase within the warranty period.

- 2.2 Rinnai will determine in its sole discretion, which classification the Product fits into and the corresponding Warranty that shall apply.
- 2.3 An Authorised Service Representative will repair or replace, at its option, the Product or any part of the Product that its examination shows to be defective. The repair or replacement shall be performed during Normal Business Hours by an Authorised Service Representative. Repair by persons other than an Authorised Service Representatives may void the Warranty.
- 2.4 Alternatively to clause 2.3 above, Rinnai can at its discretion elect to pay you an amount equivalent to the cost of repairing or replacing the Product.
- 2.5 If Rinnai provides you with either the replacement costs or replacement product, ownership of the original Product shall immediately transfer to Rinnai.
- 2.6 Rinnai is responsible for reasonable costs associated with legitimate warranty claims, including call-out of an Authorised Service Representative to inspect the Product. Rinnai is not responsible for:
- costs for tradespeople engaged by you that are not Rinnai Authorised Service Representatives.
 - any costs, including call out costs for a Rinnai Authorised Service Representatives, associated with a Product which is determined upon inspection not to be covered by this warranty.
- 2.7 Rinnai will reimburse any reasonable costs associated with making a legitimate warranty claim against Rinnai which are not otherwise specified above.
- 2.8 The Warranty of the Product requires that, in addition to all other conditions, the Purchaser conducts regular and/or preventative maintenance as may be specified by the Operating/Installation Instructions or otherwise directed by Rinnai and required by the level of usage and the usage environment, including the use of correct and uncontaminated refrigerants and lubricants. Refrigeration, plumbing and electrical works must be undertaken by licensed personnel.
- 2.9 Where a Product or failed component is replaced under warranty, the time remaining on the original Product warranty period will continue to apply and the replacement product or part will be subject to the original warranty period only.

3 CONDITIONS OF WARRANTY

- 3.1 The Purchaser may only obtain the benefit of the Warranty if the Purchaser:
- maintains and has the Product serviced in accordance with the instructions set out in the service section of the relevant Service or Owner's Manual;
 - complies with clause 7 "Purchaser's Responsibilities" on page 43;
 - notifies Rinnai within 30 days of a defect occurring or, in the case of a latent defect, becoming apparent, that a claim is being made under this Warranty; and
 - provides, in support of the claim made under this Warranty, a Proof of Purchase.
- 3.2 This document (and any statutory consumer guarantees) represents the only Warranty given by Rinnai in respect of the Product. No other person or organisation is authorised to offer any alternative warranty on behalf of Rinnai.
- 3.3 If the date of purchase cannot be established to Rinnai's satisfaction, the date shall be deemed to be 2 months after the date of manufacture or the date of sale by Rinnai, whichever is the latter.
- 3.4 This warranty applies to Products which are manufactured on or after the date of publication of this warranty but before the next date of publication of this warranty.

4 EXCLUSIONS

- 4.1 This Warranty does NOT cover:
- damage, problems or failure resulting from improper operation and/or inadequate maintenance by the Purchaser (refer Purchaser's Responsibilities section below);
 - damage, problems or failure resulting from improper or faulty installation. The Product must be installed by a Qualified Installer in accordance with applicable regulations. Where applicable, Certificate(s) of Compliance must be obtained by the purchaser from the Qualified Installer and presented to the Authorised Service Representative;
 - damage, problems or failure caused by factors external to the Product including, but not limited to, faulty or poor external electrical wiring, incorrect or faulty power supply, voltage fluctuations, over voltage transients or electromagnetic interference, inadequate or faulty gas, drainage services, or water services, including water pressure, and non-potable water;
 - damage, problems or failure caused by acts of God, fire, wind, lightning, flood, storm, hail storm fallout, vandalism, earthquake, war, civil insurrection, misuse, abuse, negligence, accident, pests, animals, pets, vermin, insects, spiders/bugs or entry of foreign objects or matter into the Product such as dirt, debris, soot or moisture;
 - damage, problems or failure caused by environmental conditions including, but not limited to, excessive moisture, salt or other corrosive substances or atmospheric conditions;
 - Product which has been installed in a portable or mobile building, structure or application including, but not limited to, a caravan, boat or trailer;
 - Product which has been re-installed at a location other than the original site;
 - any consumable item supplied with the Product including, but not limited to, an air filter, battery, fan belt, igniter or cooler pad;
 - installation of third-party components that may be attached to the Product. These include, but are not limited to, control wiring, ducting, return air filter(s) grille, register, diffuser, zone motors, controls/thermostats, pipe work and fabricated or added components. These items remain solely the responsibility of the Qualified Installer;
 - installations where electrics/electronics may be subjected to moisture/chemicals (e.g. swimming pools or nurseries);
 - any repair, which is needed as a result of an accident, misuse, abuse or negligence;
 - Product that is utilised in an environment (indoor and outdoor) outside its specified operating range; and
 - fair wear and tear to the Product.
 - On-site labour warranty on portable (non-fixed installation) Products – In respect of such Products the Purchaser must return the Product to the supplier for repair or replacement).

5 LIMITATIONS

- 5.1 Third parties are often involved in providing advice to consumers about the climate control solutions best suited to the consumer's needs. Any advice or recommendations given by such parties, including advice about Product fitness for purpose and overall system design, sizing and application are not the responsibility of Rinnai. This includes but is not limited to the heat load calculations, airflow and system balancing.
- 5.2 This Warranty does not apply to any Product installed at an Installation Site which is outside Australia.
- 5.3 Except where inconsistent with the purchaser's statutory rights and the rights given by this Warranty, all liabilities of Rinnai for any direct, special, indirect or consequential loss or damage, any damage or expense for personal injury or any loss or destruction of property, arising directly or indirectly from the use or inability to use the Product or any of its parts and/or servicing the Product, are expressly excluded.

6 TRAVEL, TRANSPORT & ACCESS COSTS

- 6.1 The Purchaser must pay freight charges, in-transit insurance expenses and travelling costs for repairs/replacements under this Warranty, that are required to be performed 50km from the nearest Rinnai branch or Authorised Service Representative.
- 6.2 Subject to clause 6.3, Rinnai will pay freight charges, in-transit insurance expenses and travelling costs for repairs/replacements that are required to be performed less than 50km from the nearest Rinnai branch or Authorised Service Representative, subject to the following:
- Rinnai will arrange for such repairs/replacements and make any payment directly to the third party to provide the freight, in-transit insurance or travel services; or
 - if Rinnai considers appropriate, it will authorise the Purchaser in writing to pay for the relevant freight charges, in-transit insurance expenses or travelling costs and then, upon provision by the Purchaser to Rinnai of a tax invoice showing those costs have been incurred, reimburse the Purchaser for such costs which are within the terms of the authorisation. If the Purchaser pays for the relevant freight charges, in-transit insurance expenses or travelling costs without written authorisation from Rinnai, Rinnai will not reimburse the Purchaser for such costs.
- 6.3 The Purchaser must pay all costs and expenses in respect of:
- any service call out fee if the Product is not accessible for service
 - making the Product accessible for service, for example, restricted access or working at heights, or the labour cost for an additional person due to OHS requirements.
 - providing a safe working environment for installation, service, maintenance or repair of the Product;
 - any surcharge applicable in respect of supplying replacement parts outside Normal Business Hours; and
 - any other costs and expenses in relation to claiming the Warranty that is not covered by clause 6.2.

7 PURCHASER'S RESPONSIBILITIES

- 7.1 The Purchaser must operate and maintain the Product in accordance with the Operating Instructions and service maintenance schedule, including conducting an appropriate number of services to the unit during the Warranty period, based on usage and the usage environment including but not limited to;
- regularly cleaning the air filter(s) and replacing them where necessary;
 - replacing expired batteries or other consumables as required;
 - ensuring that the condensate drain is kept clean and clear of obstructions.

HOW TO MAKE A WARRANTY CLAIM:

If you wish to make a warranty claim in respect of any Portable Product, please return it to the place of purchase, or if that is not possible, contact Rinnai to enquire about alternative arrangements.

If you wish to make a warranty claim in respect of any fixed Product, please contact Rinnai on the details set out below to make arrangements for an Authorised Service Representative to inspect the product.

As per clause 2.6 of the Terms and Conditions of Warranty, purchasers are responsible for the costs of any repair and/or call out fee where, on inspection, the alleged defect is found by Rinnai's Authorised Service Representative not to be covered by this warranty or any statutory consumer guarantee applicable to the Product.

The Terms and Conditions of Warranty contain important information about your rights and obligations under this warranty. Please read them fully and carefully before making a claim.

NOTICE TO CONSUMERS UNDER AUSTRALIAN CONSUMER LAW

Our goods and services come with guarantees that cannot be excluded under the Australian Consumer Law.

For a major failure with a good, you are entitled to a replacement or refund and compensation for any other reasonable foreseeable loss or damage. If the failure does not amount to a major failure and if the goods fail to be of acceptable quality, you are also entitled to have the goods repaired or replaced.

For a major failure with the service, you are entitled to cancel your service contract with us and obtain a refund for the unused portion, or to compensation for its reduced value. You are also entitled to be compensated for any other reasonably foreseeable loss or damage. If the failure does not amount to a major failure you are entitled to have problems with the service rectified in a reasonable time and, if this is not done, to cancel your contract and obtain a refund for the unused portion of the contract.

The benefits provided by this Warranty are in addition to any other rights and remedies available to a consumer under the Australian Consumer Law and any other law which may apply to the goods and or services.

Rinnai Australia Pty Ltd

ABN 74 005 138 769 | AU45204

100 Atlantic Drive, Keysborough, Victoria 3173
P.O. Box 460, Braeside, Victoria 3195
Tel: (03) 9271 6625

National Help Line

Tel: 1300 555 545*

Monday to Friday, 8.00 am to 5.00 pm EST.

**Cost of a local call may be higher from a mobile phone.
(National calls from public phones in Australia are free.)*

www.mypolo.com.au

For further information visit **www.rinnai.com.au**
or email **enquiry@rinnai.com.au**

Rinnai has a Service and Spare Parts network with personnel who are fully trained and equipped to give the best service on your Rinnai appliance. If your appliance requires service, please call our National Help Line. Rinnai recommends that this appliance be serviced every 2 years.

With our policy of continuous improvement, we reserve the right to change, or discontinue at any time, specifications or designs without notice.